



# DIRECT FASTENING TECHNOLOGY MANUAL 08/2024



# Contents

<b>Part 4: Fasteners (weblinks)</b>	<b>6</b>
<b>Part 3: Accessories and consumables compatibility</b>	<b>6</b>
<b>Part 1: Direct fastening principles and technique</b>	<b>13</b>
<b>1. Introduction</b>	<b>13</b>
1.1 Definitions and general terminology	13
1.2 Reasons for using direct fastening	13
1.3 Direct fastening applications	15
<b>2. The direct fastening system</b>	<b>16</b>
2.1 Fasteners	17
2.2 Manufacturing process	18
2.3 Fastener raw material	19
2.4 Types of Hilti direct fastening tools	20
2.5 Operating principles	22
<b>3. Health and safety</b>	<b>25</b>
3.1 Operator safety	25
3.2 Fastening safety	30
3.3 Quality of installation	31
<b>4. Corrosion</b>	<b>33</b>
4.1 Corrosion protection of direct fastening systems	33
4.2 Fastener selection	35
<b>5. Steel base material</b>	<b>39</b>
5.1 Anchoring mechanisms	39
5.2 Factors influencing pull-out resistance	41
5.3 Suitability of the steel for fastening	46
5.4 Application limit diagrams	47
5.5 Thin steel base material	48
5.6 Types of load and modes of failure	49
5.7 Effect of fasteners on structural steel	56
<b>6. Concrete base material</b>	<b>61</b>
6.1 Anchoring mechanisms	61
6.2 Factors influencing resistance to pull-out	63
6.3 Effect of time on pull-out resistance	66
6.4 Effect on concrete components	67

<b>7. Masonry base material</b>	<b>68</b>
7.1 General suitability	68
<b>8. Temperature effects on the fastening</b>	<b>69</b>
8.1 Effect of low temperatures on fasteners	69
8.2 Effect of low temperatures on fastenings to steel	70
8.3 Fire rating of fastenings to steel	72
8.4 Fire rating of fastenings to concrete	74
<b>9. Design concepts</b>	<b>76</b>
<b>10. Determination of technical data for fastening design</b>	<b>78</b>
10.1 Fastenings to steel	78
10.2 Profile sheet fastenings	79
10.3 Fastenings to concrete (standard DX / GX / BX)	80
10.4 DX fastenings to concrete (DX-Kwik)	82
10.5 Fastener design in the USA and Canada	83
<b>Part 2: Fastener selection guide</b>	<b>84</b>
<b>1. Selecting the right fastener</b>	<b>85</b>
1.1 Selection based on the type of concrete	86
1.2 Selection based on environmental conditions	93
<b>2. Design concepts</b>	<b>95</b>
<b>3. Nomenclature/symbols</b>	<b>96</b>
<b>4. Tips for users</b>	<b>98</b>
<b>5. Nail and stud designation</b>	<b>103</b>
<b>Part 3: Accessories and consumables compatibility</b>	<b>108</b>
<b>Powder-actuated tools</b>	<b>109</b>
DX 2                      Semi-automatic powder-actuated tool for fastening single nails	109
DX 351                    Powder-actuated tool for interior finishing applications	110
DX 351 F8                Powder-actuated tool for interior finishing, mechanical and electrical applications	110
DX 351 BT                Powder-actuated tool for fastening X-BT threaded studs	111
DX 351 BTG              Powder-actuated tool for fastening gratings	111
DX 351-CT                Fully automatic powder-actuated tool for fastening ceiling fasteners to concrete or steel	111
DX 450                    Powder-actuated tool – standard	112
DX 450-FA                Powder-actuated tool – facade	112
DX 460-MX                Powder-actuated tool for fastening collated nails	113
DX 460-F8                Powder-actuated tool for fastening single nails	113

DX 460-SM	Powder-actuated tool for fastening metal decks	116
DX 5 MX	Digitally enabled powder-actuated tool for fastening collated nails	117
DX 5 F8	Digitally enabled powder-actuated tool for fastening single nails	117
DX 5 IE	Powder-actuated tool for fastening insulation	120
DX 5 GR	Powder-actuated tool for fastening gratings	120
DX 5 SM	Powder-actuated tool for fastening metal decks	120
DX 5 F10	Powder-actuated tool for fastening W10 threaded studs	120
DX 76 PTR	Powder-actuated tool for fastening metal decks with collated nails	126
DX 76 PTR	Powder-actuated tool for fastening metal decks with single nails	126
DX 76 PTR	Powder-actuated tool for fastening metal decks on concrete – DX-Kwik	127
DX 76 PTR	Powder-actuated tool for fastening HVB shear connectors	127
DX 76 PTR	Powder-actuated tool for fastening gratings and checker plates	128
DX 76 PTR	Powder-actuated tool for fastening heavy duty applications	128
DX 76 MX	Powder-actuated tool for fastening metal decks with collated nails	129
DX 76	Powder-actuated tool for fastening metal decks with single nails	129
DX 76	Powder-actuated tool for fastening metal decks on concrete – DX-Kwik	130
DX 76	Powder-actuated tool for fastening HVB shear connectors	130
DX 76	Powder-actuated tool for fastening gratings and checker plates	131
DX 76	Powder-actuated tool for fastening heavy duty applications	131
DX-860-ENP	Powder-actuated tool for fastening metal decks	132
DX 860-HSN	Powder-actuated tool for fastening metal decks	132
DX 9-ENP	Digitally enabled powder-actuated tool for fastening metal decks	133
DX 9-HSN	Digitally enabled powder-actuated tool for fastening metal decks	133
<b>Cartridges – Propellants for powder-actuated tools</b>		<b>134</b>
<b>Gas-actuated tools</b>		<b>135</b>
GX 90 WF	Gas-actuated tool for wood framing	135
GX 120	Gas-actuated tool for interior finishing applications	136
GX 120-ME	Gas-actuated tool for mechanical and electrical applications	136
GX 3	Gas-actuated tool for interior finishing and building construction applications	137
GX 3-ME	Gas-actuated tool for mechanical and electrical applications	137
GX 2	Gas-actuated tool for interior finishing and building construction applications	138

<b>Gas cans</b>		<b>138</b>
<b>Battery-actuated tools</b>		<b>139</b>
BX 3-BT	Battery-actuated tool for multi-purpose and electrical connection applications	139
BX 3-BTG	Battery-actuated tool for fastening gratings	139
BX 3-IF	Battery-actuated tool for interior finishing and building construction applications	140
BX 3-ME	Battery-actuated tool for mechanical and electrical applications	140
BX 3 02	Battery-actuated tool for mechanical and electrical applications	141
BX 3-L 02	Battery-actuated tool for interior finishing, mechanical and electrical and building construction applications	141

Use the hyperlink function to open the below listed Product Data Sheets.

### Part 3: Accessories and consumables compatibility

#### Powder-actuated tools



<a href="#">DX 6</a>	<a href="#">Powder-actuated tool</a>	
----------------------	--------------------------------------	--

#### Battery-actuated tools



<a href="#">BX 4-22</a>	<a href="#">Cordless concrete nailer NURON</a>	
-------------------------	--	--

### Part 4: Fasteners

#### Siding and decking nails



<a href="#">X-ENP</a>	<a href="#">Siding and decking nail</a>	
<a href="#">SDK2, PDK2</a>	<a href="#">Sealing cap for cladding fastening</a>	
<a href="#">X-ENP2K</a>	<a href="#">Siding and decking nail</a>	
<a href="#">X-HSN 24</a>	<a href="#">Diaphragm decking nail</a>	
<a href="#">NPH</a>	<a href="#">Siding and decking nail</a>	

#### Shear connectors



<a href="#">X-HVB</a>	<a href="#">Shear connector</a>	
-----------------------	---------------------------------	--

**General purpose nails**

X-X	Nail for fastening to concrete and steel	
X-U	Nail for fastening to concrete and steel	
X-P	Nail for fastenign to concrete and steel	
X-C	Nail for fastening to concrete and sand lime masonry	
X-S	Nail for fastening drywall track to steel	
DS	Heavy-duty nail for fastening to concrete and steel	
EDS	Nail for fastening to steel	
X-R	Stainless steel nail for fastening to steel	
X-CR	Stainless steel nail for fastening to concrete, sand lime masonry and steel	
X-CR	Stainless steel nail for fastening to steel	
X-CT	Nail for forming or other temporary use	

**Threaded studs**

DX-KWIK X-M6 H, X-M8 H, DNH, X-DKH	Threaded stud and nail	
X-M6, X-W6, X-M8, M10, W10	Threaded stud for fastening to concrete	
X-EM6H, X-EW6H, X-EF7H, X-EM8H, X-EM10H, X-EW10H	Threaded stud for fastening to steel	
X-BT	Stainless steel threaded stud	
S-BT	Screw-in stainless steel and carbon steel threaded stud	
S-BT-HL	Screw-in stainless steel and carbon steel threaded stud	
X-ST-GR	Stainless steel threaded stud for fastening to steel	
X-CR M	Stainless steel threaded stud for fastening to concrete and steel	
X-BT-ER	Stainless steel threaded stud for electrical connection	
S-BT-ER (HC), S-BT-EF (HC)	Screw-in stainless steel and carbon steel threaded stud	
S-BT-ER HL (HC), S-BT-EF HL (HC)	Screw-in threaded stud (duplex coated, stainless steel) for electrical connections	

**Standoff adapters**

Adapter	Standoff adapter including S-BT HL	
---------	------------------------------------	--



### Grating fastening system



X-FCM	Grating fastener disc (zinc coated)	PDF
X-FCM-F	Grating fastener disc (duplex coated)	PDF
X-FCM-R	Grating fastener disc (stainless steel)	PDF
X-FCM-F L	Large grating fastener disc (duplex coated)	PDF
X-FCM-R L	Large grating fastener disc (stainless steel)	PDF
X-FCM-R HL	High load grating fastener disc (stainless steel)	PDF
X-FCM-F NG	Narrow grating fastener disc (duplex coated)	PDF
X-FCM-R NG	Narrow grating fastener disc (stainless steel)	PDF
X-FCI-M	Grating fastening system	PDF
X-GR	Grating fastening system	PDF
X-FCS-R	Grating element	PDF
X-MGR	Grating fastening system	PDF
X-FCP	Checker plate fastening system	PDF

### Suspended ceiling fasteners



X-SCR	Suspended ceiling fastener	PDF
X-SCO/N	Suspended ceiling fastener	PDF
X-SCH	Suspended ceiling fastener	PDF
X-CC DKH	Suspended ceiling fastener	PDF
X-DKH	Suspended ceiling fastener	PDF
X-HS DKH	Suspended ceiling fastener	PDF

### Insulation fasteners



X-IE-G 6, X-IE-G 9	Insulation fastener	PDF
X-IE 6, X-IE 9	Insulation fastener	PDF
XI-FV ETICS	Insulation fastener	PDF
X-SW	Soft washer fastener	PDF

### Form stop fasteners



X-FS	Form stop	PDF
X-DFS	Double form stop	PDF

**Battery and gas-actuated tool fastening system**

X-P B4 MX, X-P B3 MX, X-P G3 MX, X-P G2 MX, X-GHP MX	Concrete nails (collated)	
X-C B4 MX, X-C B3 MX, X-C G3 MX, X-C G2 MX, X-GN MX	Concrete nails (collated)	
X-S B4 MX, X-S B3 MX, X-S G3 MX, X-EGN MX	Fastener for gas-actuated tool	

**Hanger fasteners**

BX -Kwik	Electrical hanger system	
X-HS and X-CC	Threaded hanger and loop hanger system	
X-MW MX, X-MW ALH	Wire hanging system	
X-EHS MX, X-ECC MX	Electrical hanger system	
X-DHS MX	Pipe support system	

**Electrical fasteners**

X-EKB MX	Cable clasp	
X-ECH MX	Cable holder	
FB	Conduit clip	
DFB	Butterfly conduit clip	
X-DFC	Double fire clip	
X-MCT-FE MX	Metal cable tie holder	
X-ECH-FE MX, X-EKB-FE MX	Circuit integrity fastener	
X-FB	Electrical conduit fastener	
X-DFB, X-EMTC	Electrical conduit fastener	
X-FB-E, X-DFB-E	Electrical conduit fastener	
X-UCS MX	Universal conduit saddle	
X-UCS-S MX	Universal conduit saddle for rigid pipe	
X-ECT MX, X-UCT MX, X-EKS MX	Electrical cable tie and conduit clip fastener	
X-UCT-E MX	Universal cable tie holder	
X-ET	Nail for fastening plastic electrical cable tray and junction box	
X-TH	Pipe clamp mount	
X-TT	Textile tape	

**Wood nails**

GX-WF	Wood framing nail	
-------	-------------------	--



Part 1:

## Direct fastening principles and technique

# 1. Introduction

## 1.1 Definitions and general terminology

Hilti direct fastening technology is a technique in which specially hardened nails or studs are driven into steel, concrete or masonry by a piston-type tool. Materials suitable for fastening by this method are steel, wood, insulation and some kinds of plastic. Fastener driving power is generated

by a power load (a cartridge containing combustible propellant powder, also known as a “booster”), combustible gas or by a battery. During the driving process, base material is displaced and not removed. In Hilti terminology, DX stands for “powder-actuated”, GX for “gas-actuated” and BX stands for “battery-actuated” systems (i.e. propellant free).”

## 1.2 Reasons for using direct fastening

“The illustrations below show some of the main reasons why many contractors take

advantage of the benefits of powder-, gas- or battery-actuated fastening.

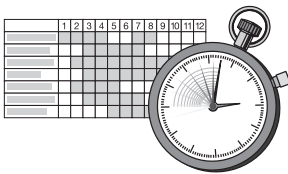

Speed is important.

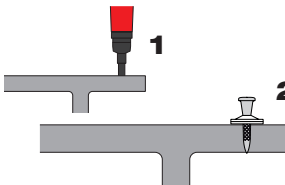

An easy-to-use, uncomplicated fastening system is required.

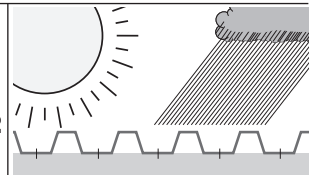

A weather-independent fastening system is required.



Electric power is not available or electric cables would hinder the work.

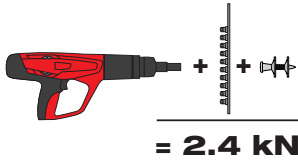

A complete fastening system with assured strength is required.



Drilling is not viable because of noise.

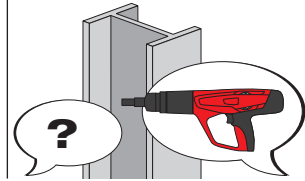

Drilling would be too difficult.

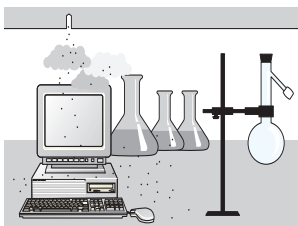

Drilling would cause too much dust.

In addition, there are specific reasons why contractors may use battery-actuated fastening:



Gas cans or combustion systems are not allowed

### 1.3 Direct fastening applications

Typical applications for powder- or gas-actuated fastening are shown in the illustrations below:

- Fastening thin metal sheets: roof decking wall liners and floor decking
- Fastening thicker steel members: e.g. metal brackets, clips
- Fastening soft materials such as wooden

battens or insulation to steel, concrete or masonry

- Threaded studs for suspended ceilings, installing building services, bar gratings or chequer plate floors
- Connections for composite structures: fastening nailed composite shear connectors

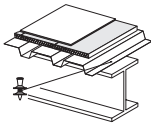

Roof decking

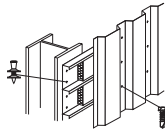

Wall liners

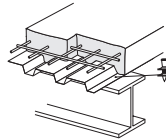

Floor decking

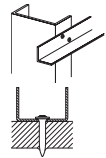

Metal brackets, clips and tracks

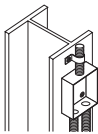

Fixtures for mechanical and electrical installations

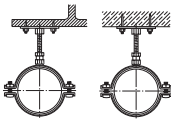

Hangers with threaded connectors

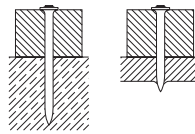

Wooden battens fastened to steel or concrete

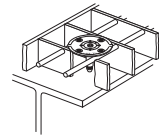

Grating fastenings

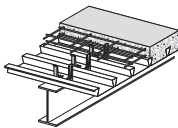

Shear connectors

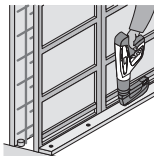

System formwork

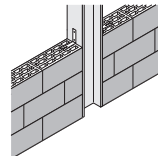

Wall-tie to steel and concrete

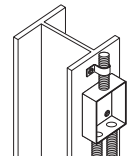

Mechanical and electrical fixtures

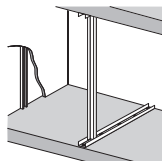

Drywall track to concrete and steel

## 2. The direct fastening system

The fastener, tool and driving energy form a fastening system with its own specific characteristics. Examples of Hilti direct

fastening system components are shown below.

Fasteners	Fastening tools	Driving energy
		
Powder-actuated tool		
		
Gas-actuated tool		
		
Battery-actuated tool		



## 2.1 Fasteners

Fasteners can be classified in three general types: nails, threaded studs and composite fasteners.

### Nails

Siding and decking nails



General purpose nails

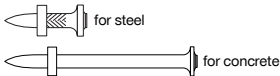

### Threaded studs

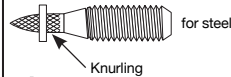

Blunt-ended fastener  
(requires pre-drilling)

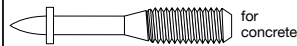

### Pre-mounted fasteners

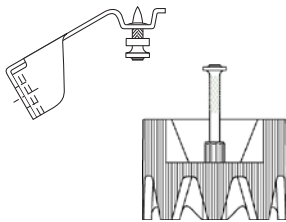

### Multi-part fasteners

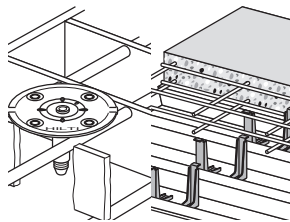

The nails used (also known as drive pins) are of a special type equipped with washers to meet the needs of the application and to provide guidance when driven. Threaded studs are essentially nails with a threaded upper section instead of a head. Composite fasteners are an assembly consisting of a nail with an application-specific fastening component such as a clip, plate or disk made of metal or plastic. Siding and decking nails can be recognized by their washers which are specially designed to hold down the metal sheets and to absorb excess driving energy. Fasteners designed for driving into steel usually have

knurled shanks which increase their pull-out resistance. Fasteners for use on concrete have longer shanks than those for use on steel. Threaded studs may have either a metric (M6, M8 or M10) or Whitworth ( $1/16''$ ,  $5/16''$  or  $3/8''$ ) thread.

Nails and threaded studs are commonly zinc-plated for resistance to corrosion during transport, storage and construction. As this degree of protection is inadequate for long-term resistance to corrosion, use of these zinc-plated fasteners is limited to applications where they are not exposed to the weather or a corrosive atmosphere during their service life. The zinc layer on

fasteners driven into steel is, in fact, a disadvantage in that it reduces pull-out resistance. For this reason, the thickness of zinc on the fastener must be optimized to ensure good corrosion protection as well as high holding power. During production, tight control of the galvanizing process is necessary to prevent excess zinc thickness and thereby poor fastening performance. Fasteners must be 2 to 3 times harder than the material into which they are driven. The tensile strength of structural steel is

commonly between 400 and 600 MPa. Fasteners for use on steel thus require a strength of approximately 2000 MPa. As Rockwell hardness is much easier to measure than strength, but good correlation exists between hardness and strength, this characteristic is used as a parameter in the specification and manufacturing of the fasteners. In the table below, HRC hardness is given for a range of tensile strengths (DIN 50150).

Tensile strength									
(MPa)	770	865	965	1810	1920	1995	2070	2180	2215
HRC	20.5	25.5	30	52.5	54	55	56.5	58	59

## 2.2 Manufacturing process

### Standard hardened steel fasteners

Almost all power-actuated fasteners used throughout the world are manufactured from carbon steel wire which is subsequently thermally hardened to provide the strength needed for driving into steel and concrete. In nail manufacturing, shank diameter is determined by the wire diameter used. Threaded studs are made from wire corresponding to the required thread diameter. The manufacturing process, which is summarized in the diagram below, consists of cutting the wire to length, shaping the head, knurling, forging or thermo pulling the point, hardening, galvanizing and assembling with washers. The process of hardening the steel to more than HRC 50 combined with the zinc plating presents a risk of hydrogen embrittlement. This risk is mitigated by heat-treating the

galvanized product at the optimum temperature for the correct time. Galvanized and heat-treated fasteners are subjected to impact bending tests to check the effectiveness of the process. Depending on their intended application, some fasteners are additionally sampled and tested under tension and shear.

### Manufacturing Process

#### Standard zinc-coated fasteners

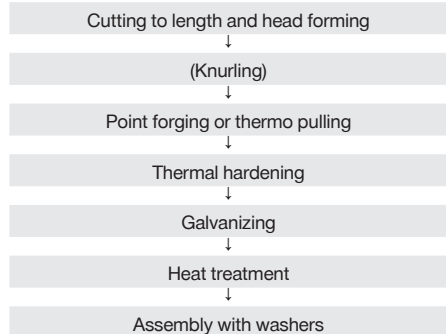

## Stainless steel fasteners

Hilti introduced the first powder-actuated stainless steel fastener in 1994. These fasteners, which are not thermally hardened, are manufactured from special stainless steel wire with an ultimate tensile strength of 1850 MPa. One effect of using steel of such high strength as a raw material is that the forming and forging processes present greater technical difficulties. These fasteners, on the other hand, suffer no

risk of hydrogen embrittlement and their strength decreases only very slightly when subjected to high temperatures such as in a fire.

### Manufacturing Process Stainless Steel Fasteners

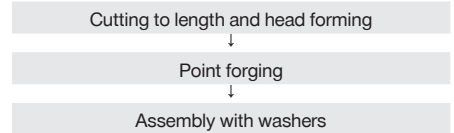

## 2.3 Fastener raw material

Hilti standard zinc plated fasteners are made from carbon steel wire with an ultimate tensile strength of 590 to 760 MPa.

Hilti X-CR / X-BT stainless steel fasteners are made from high-strength nitrogen alloyed stainless steel wire (Hilti designation CR500) or ferritic-austenitic corrosion resistant duplex steel 1.4462.

Nickel and chromium are the components of stainless steel that make it resistant to corrosion. CR500 steel is compared to commonly used stainless steels like AISI 304 and 316 (European A2 and A4) in the graph at the right. Note that CR500 steel contains considerably more nickel and chromium than both 304 and 316.

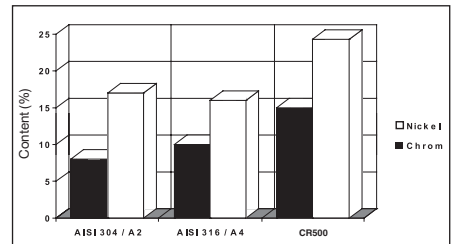

Another comparison of interest is the difference in ultimate tensile strength, as shown in the graph at the right.

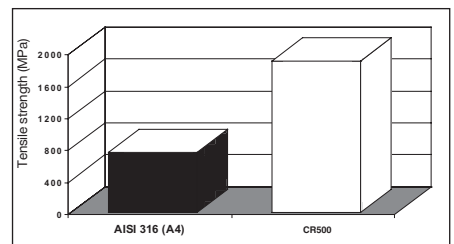

## 2.4 Types of Hilti direct fastening tools

Hilti currently offers three types of direct fastening tools: powder-actuated, gas-actuated and battery-actuated.

### 2.4.1 Powder-actuated tools



These tools rely on cartridges of different power levels as propellant. When ignited, the cartridge transfers energy to a piston which, in turn, drives the fastener into the base material.

All Hilti powder-actuated tools are classified as low-velocity tools.

Class of powder-actuated tool	Average test velocity in m/s [fps]	Maximum single test velocity in m/s [fps]
Low-velocity	100 [328]	108 [354]
Medium-velocity	150 [492]	160 [525]
High-velocity	>150 [492]	>160 [525]

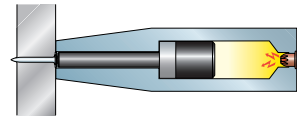

### 2.4.2 Gas-actuated tools



These tools rely on gas as propellant. Expanding the gas transfers energy to a piston which, in turn, drives the fastener into the base material.

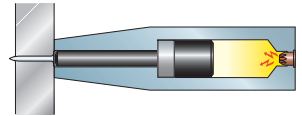

Hilti manufactures gas-actuated tools using two distinct technologies. The first (used notably in models GX 2 and GX 90 WF) uses a fan to mix the propellant with ambient air. The second (used notably in the GX 120 and GX 3) uses a Hilti-designed mechanism requiring no external power to mix the gas and air in the combustion chamber.

### 2.4.3 Battery-actuated tools



This tool is propellant-free. The energy moving the piston is generated by an electrical motor, two springs and a belt. The only source of energy required is a 22V battery which is interchangeable with other tools from the Hilti 22V platform family.



## 2.5 Operating principles

All Hilti direct fastening tools feature a piston. There are three ways the piston can come into contact with the fastener when an operator triggers a tool – referred to as operating principles. They are described in the diagram below.

It is important to bear in mind that the operating principle used for a given fastening point modifies the application's limit, particularly when fastening on steel.

Operating principle	Characteristics	
Co-acting operation	<ul style="list-style-type: none"> <li>• <math>X &gt; 0</math> ; <math>Y = 0</math></li> <li>• Highest application limit</li> <li>• Lowest recoil</li> </ul>	
Impact operation	<ul style="list-style-type: none"> <li>• <math>X = 0</math> ; <math>Y &gt; 0</math></li> <li>• Lower application limit</li> <li>• Higher recoil</li> </ul>	
Contact operation	<ul style="list-style-type: none"> <li>• <math>X = 0</math> ; <math>Y = 0</math></li> <li>• Lowest application limit</li> <li>• Highest recoil</li> </ul>	

It should be noted that 100% co-acting operation in Hilti tools can be only achieved by pushing the fastener all the way against the piston with a ramrod or, if the tool is so designed, with a built-in ramrod mechanism. Tools with nail magazines cannot operate with 100% co-action because of the need for clearance between the piston end and the collated nail strip. Some single-shot tools allow the operator to make an impact-type tool work as a co-acting tool by using a ramrod.

### 2.5.1 Cartridges (power loads, boosters)

Cartridges for powder-actuated fastening tools are available in various standard sizes and each size is available in up to 6 power levels. In the United States, the powder in a cartridge, the sensitivity of the primer, and the cartridge dimensions are governed by technical data published by the Powder-Actuated Tool Manufacturers Institute, Inc.

(PATMI). PATMI defines the power level by the velocity measured in a standard test in which a standardized 350 grain [22.7gram] cylindrical plunger is fired from a standardized apparatus. The identification and limitations of use are addressed in ANSI A10.3-2013.

#### PATMI colour codes, power levels and definition of cartridges

Size	Colour code	Power level	Velocity of 350 grain slug		Calculated energy (joules)		
			ft./sec.	[m/sec.]	minimum	average	maximum
6.8 / 11 [Cal. 27 short]	Gray	1	370 ± 45	[113 ± 13.7]	111	144	182
	Brown	2	420 ± 45	[128 ± 13.7]	148	186	228
	Green	3	480 ± 45	[146 ± 13.7]	200	243	291
	Yellow	4	560 ± 45	[171 ± 13.7]	280	331	386
	Red	5	610 ± 45	[186 ± 13.7]	337	392	452
	Purple / black	6	660 ± 45	[201 ± 13.7]	399	459	524
6.8 / 18 [Cal. 27 long]	Green	3	550 ± 45	[168 ± 13.7]	269	319	373
	Yellow	4	630 ± 45	[192 ± 13.7]	361	419	480
	Blue	4.5	725 ± 45	[221 ± 13.7]	488	554	625
	Red	5	770 ± 45	[235 ± 13.7]	554	625	700
	Purple / black	6	870 ± 45	[265 ± 13.7]	718	798	883

In Europe, the European Standard EN 16264 specifies cartridge dimensions, colour codes and power levels, which are defined in terms of energy delivered

when a cartridge is fired in a standardized apparatus. EN 16264 specifies a 80 gram plunger.



## EN 16264 colour codes, power levels and energy scale

Colour code	Power level	Energy scale
White/Brown	weakest	2
Green	weak	3
Yellow	medium	4
Blue	heavy	5
Red	very heavy	6
Black	heaviest	7



### 3. Health and safety

The safety of powder-actuated fastening systems can be clustered into two categories:

- Operator safety refers to safeguarding the operator and bystanders.
- Fastening safety refers to the adequacy of the in-place fastenings.

#### 3.1 Operator safety

This refers to the measures taken to ensure that the tool does not endanger the operator and/or bystanders by firing at an overly high velocity, firing under the wrong conditions, generating excessive noise, or being used in the wrong way.

##### The piston principle

One of the main concerns about the use of powder-filled cartridges is the risks associated with a fastener missing the base material, or with a base material too weak to absorb the nail's energy. The piston principle ensures that the energy from the propellant in the cartridge is transferred to a piston which, in turn, drives the fastener. Because the piston is captive within the tool, it will absorb app. 95% of the driving energy in case a fastener misses the base material or the material is too soft for the fastener. As a consequence, the fastener will exit the tool at a speed that is far lower and less dangerous than that of tools which are not based on a piston.

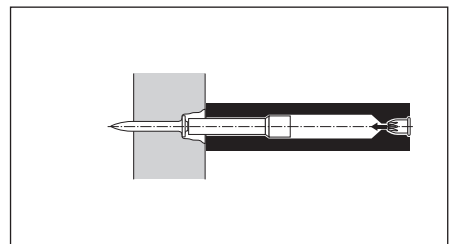
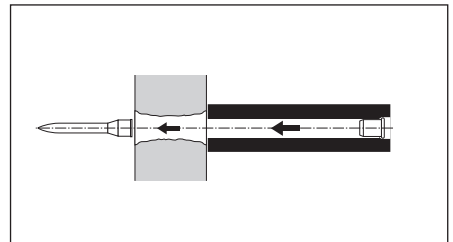

##### Tool safety mechanisms

To minimize the potential hazards during tool usage, Hilti has implemented the following safety mechanisms in all of its direct fastening tools.

### Drop-firing safety

The drop firing safety mechanism prevents the tool from firing if dropped unintentionally. This mechanism is so designed that the tool, cocked or uncocked, will not fire when dropped at any angle onto a hard surface.



### Trigger safety

The trigger in Hilti's DX- and GX-tools is uncoupled from the firing pin mechanism until the tool is fully compressed against the work surface. This mechanism ensures that pulling the trigger alone cannot cause the tool to fire.



### Contact pressure safety

Hilti's direct fastening tools can only operate when pressed against the work surface. This requires a force of at least 50 N (5.1 kg, or 11.2 pounds). Tools with large base plates, such as DX 76 and GX 120, feature an additional surface contact pin that must also be pressed to allow the tool to operate.



### Unintentional firing safety

Hilti's direct fastening tools will not operate unless first pressed against a work surface and then actioned using the trigger. This Hilti-designed feature ensures that no fastener exits a tool without the operator specifically intending it and focusing on the tool.



## Powder cartridges and operator safety

EN16264 requires submitting each cartridge to overpressure tests in each of the tools for which it is intended. This ensures that the plastic collation strip is of adequate strength. EN16264 also defines the maximum amount of unburnt powder a cartridge may leave after combustion, as this residue may explode and cause injuries to the operators and to bystanders. Meeting this requirement is a prerequisite for CE conformity.

The Hilti cartridges come in packages that address all the norms mentioned above. Each package displays cartridge energy level, marking on US scale and on European scale, in addition to the CE marking and CIP logo, as in the following picture illustrated.

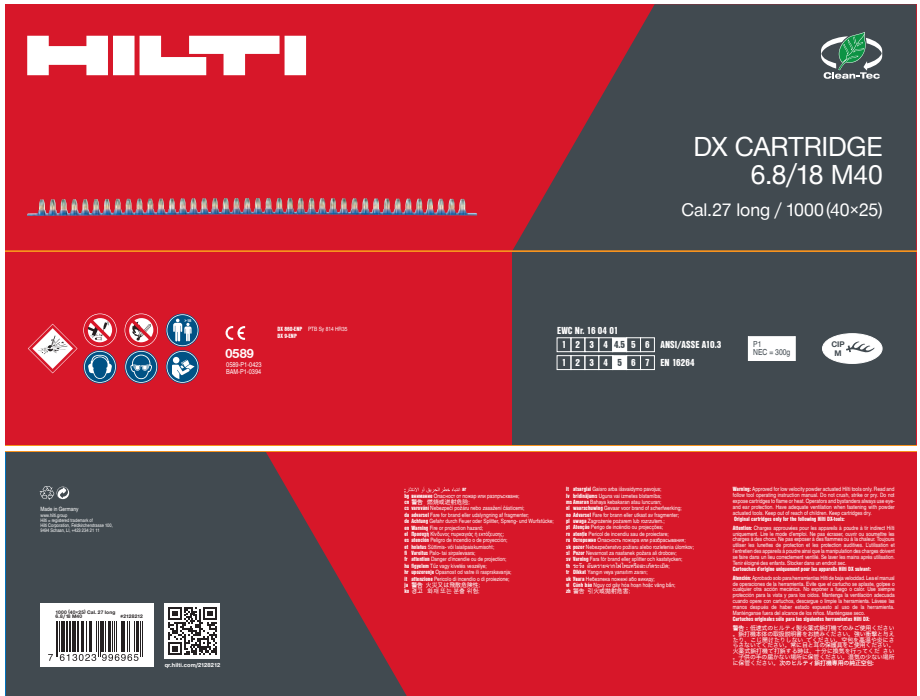

The identification and limitations of cartridge use in the U.S. are addressed in the ANSI/ASSE A10.3 norm.

Always review and follow the Operating Instructions in addition.

## Gas cans and operator safety

Norms and standards relevant to gas cans include EN12205 and ISO 11118 as of 2018, which regulate the physical structure of gas cans. They also include the UN 1950 or UN 3150 norms, which define the conditions under which gas can shipping and distributing is considered safe. Regional regulations also apply depending on the operator’s location: ADR/RID for Europe and ORM-D for the United States. All Hilti gas cans strictly abide by these norms.

To ensure that Hilti’s gas cans are used in the appropriate conditions, each can features safety information in text and pictogram formats. In particular, it displays its expiry date, the maximum temperature it may be exposed to, its pressure level, and the “Extremely flammable” logo. The enclosing package also displays this information, in addition to recommended storage conditions. And the accompanying leaflet provides the complete list of potential hazards associated with the gas can.

### GC 42 for use with the Hilti GX 3 tool.

For professional use only. Strictly for intended use only. Read the operating instructions and the safety regulations before use. Keep out of reach of children. **See edge of can for expiration date and lot number. Extremely flammable gas. Contains gas under pressure; may explode if heated. Contains Isobutane, Propane, Propane.** Pressurized container. Do not pierce or burn, even after use. Protect from sunlight. Do not expose to temperatures exceeding 50°C/122°F. Do not spray on an open flame or other ignition source. Keep away from heat/sparks/open flames/hot surfaces. — No smoking. Store the container in a well ventilated place. Recommended storage temperature: 5°C to 25°C (41°F to 77°F).

### GC 42 Gasdose zur Verwendung im Gerät Hilti GX 3.

Nur für professionellen Gebrauch. Benutzung ausschliesslich gemäss Verwendungszweck. Vor der Inbetriebnahme Bedienungsanleitung und die Sicherheitsvorschriften lesen. Darf nicht in die Hände von Kindern gelangen. **Verfallsdatum und Abfüll-Los siehe Dosenrand. Extrem entzündbares Gas. Enthält Gas unter Druck; kann bei Erwärmung explodieren. Enthält: Isobutan, Propan, Propan.** Behälter steht unter Druck: Nicht durchstechen oder verbrennen, auch nicht nach der Verwendung. Vor Sonnenbestrahlung schützen und nicht Temperaturen von mehr als 50 °C/122°F aussetzen. Nicht gegen offene Flamme oder andere Zündquelle sprühen. Von Hitze/Funkentöffener Flamme/heißen Oberflächen fernhalten - Nicht rauchen. Nur in gut gelüfteten Bereichen verwenden. Behälter an einem gut gelüfteten Ort aufbewahren. Empfohlene Lagertemperatur 5°C bis 25°C (41°F bis 77°F).

### GC 42 pour système Hilti GX 3.

Usage réservé aux professionnels, uniquement dans le cadre d’une utilisation normale. Lire le manuel d’utilisation et toutes les instructions de sécurité avant utilisation. Tenir hors de portée des enfants. **Date d’expiration sur la bordure de la cartouche. Gaz extrêmement inflammable. Contient un gaz sous pression; peut exploser sous l’effet de la chaleur. Contient: Isobutane, Propane, Propane.** Récipient sous pression: ne pas perforez, ni brûler, même après usage. Protéger du rayonnement solaire. Ne pas exposer à une température supérieure à 50 °C/122 °F. Ne pas vaporiser sur une flamme nue ou sur toute autre source d’ignition. Tenir à l’écart de la chaleur/des étincelles/des flammes nues/des surfaces chaudes. - Ne pas fumer. Stocker les cartouches dans un endroit bien ventilés. Température recommandée pour le stockage: 5°C à 25°C (41°F à 77°F).

81 ml **115**

(2.74 fl. oz.)

Made in Germany

www.hilti.com

Hilti Corporation, FL-9494 Schaan, Tel. +423/234 21 11

Hilti = registered trademark of Hilti Corporation, Schaan, LI



Danger  
Gefahr

2108613-10/2014



To enable the efficient tracking of any issue, the production lot number is also printed on each gas can and package.

The side illustration shows the typical graphical layout of a Hilti gas can.

The Hilti tools only operate with Hilti gas cans. This ensures that the tool receives gas in the right amount and composition, minimizing safety risks.

**Noise-related operator safety**

Hilti measures the noise its direct fastening tools emit as per the EN 15895 international standard to help operators and safety engineers plan the work in a way that minimizes risks. However, it should be noted that other ambient construction noises frequently compound with the tool's noise, which warrants additional precautions to protect operators. As a general rule, operators should always wear ear protection when operating the tools.

**Vibration-related operator safety**

Hilti direct fastening tools are not considered to produce vibrations as defined in international standards. However, as a precautionary measure, it is recommended to use the weakest possible cartridges to perform any given task, as well as to follow the instructions contained in the IFU.

**Promoting operator safety through signaling and documentation**

To ensure the safety of the operator and of bystanders, it is essential to follow the instructions contained in the Operating Instructions. Safety measures are also featured on pictograms inside the product carrying cases and on the consumables.



Hilti also covers safety measures as part of the operator training modules its local offices offer. The operators completing training receive a certificate of completion and/or an operator ID as required by local regulations. In some countries, the operators also get access to online material that serves as a refresher.

### 3.2 Fastening safety

The safety of a fastening point depends for a good part on the manufacturer correctly anticipating the conditions in which its tools and fasteners will be used on jobsites. This involves:

- 1) engineering and testing fastening systems within the framework of specific applications
- 2) ensuring that the finished products strictly match their technical specifications
- 3) ensuring that the fastening work on jobsites is performed as it is intended to be

#### Engineering and testing

Sources of information about the engineering and testing of a fastening system include the manufacturer's technical literature, official approvals and publications in technical journals. Hilti provides all of these for its products.



The use of a non-Hilti fastening system by an operator should be made contingent upon proof that the fastening system has been engineered and tested for the application the operator intends to perform.



#### Finished product quality

It is important that the manufacturer have a production quality control system. This is necessary for ISO 9001 certification. All Hilti production facilities are 9001 certified.

### 3.3 Quality of installation

Hilti contributes to the quality of the fastening work in the four following ways:

- 1) It provides application guidelines.
- 2) It provides technical advisory services.
- 3) Each box of nails designed and/or approved for specific applications comes with a plastic gauge enabling the operator to check if the nail's stand-off on the base material is within the acceptable margin
- 4) It manufactures devices enabling the tensile testing of fasteners. Threaded studs and certain decking fasteners can be tested in their final position on a jobsite. Other fasteners can be tested using a pull-over test specimen.



Checking the standoff of an ENP2 roof deck fastening with a plastic gauge



Pull-out test of an ENP fastening with a HAT28 tester and X-ENP adapter

As construction professionals demand fastening systems that are dependable without question, Hilti integrates functional reliability into the development, manufacturing, selling and servicing of its fastening systems. It does so paying particular attention to the reliability level required of each system, and the conditions in which it will be used.

During the development phase, Hilti engineers test the reliability of prototypes and system components regularly. In the plant, quality controls take place throughout the manufacturing process to ensure that the products are produced according to specifications.

When the first pilot production lots are delivered, contractors test them on jobsites. Adequate performance by the pilot production lots ensures that the products will be of good quality when mass-produced.

Hilti's sales staff gets trained to be in a position to advise customers on which system to use for their application, demonstrate how to use tools, and warn them about potential hazards.

Finally, Hilti's highly skilled tool repair and maintenance staff ensures that the fastening system functions optimally over the long run.





## 4. Corrosion

For decades, Hilti is concerned about corrosion of fastening systems and has gained a lot of experience in this area based on laboratory- and field tests. Extensive testing and research are conducted in test facilities of Hilti Corporate Research department, located around the world in different climate zones. Hilti strives to provide the best possible

support to customers for selecting the right product for safe and reliable fastening solutions.

This chapter gives an overview of corrosion protection solutions for Hilti Direct Fastening elements. More details on corrosion are described in the Hilti corrosion brochure „Corrosion handbook 2015“.

### 4.1 Corrosion protection of direct fastening systems

Carbon steel fasteners are subject to corrosion (red rust) when exposed to humidity.

Zinc is the coating most commonly applied on fasteners. Humidity attacks it before it attacks the carbon steel core. Thanks to Zinc's electro-chemical properties, this produces white rust on the coating but delays the formation of red rust on the core material.

Zinc has different removal rates depending on the surrounding environment.

The lifetime of zinc-based protection against corrosion is a function of two parameters: the environment's aggressiveness and the zinc's thickness. Depending on the degree of anti-corrosion protection required, additional layers of Zinc can be applied through passivation or organic topcoat.

Different variants of coating systems can be used to prevent fasteners from rusting. They are described in the following paragraphs.

#### **Galvanic zinc coating:**

This type of coating is generally suitable for environments with no corrosive potential. It is typically applied via an electrochemical process. Thicknesses up to 20 microns are possible, including passivation layer.

#### **Hot dip galvanizing (HDG):**

HDG is applied by dipping the parts to be protected against corrosion in a liquid zinc bath. The coating thickness can reach up to 80-100 microns, offering additional protection compared to galvanic zinc.

**Duplex coating:**

An alternative to hot dip galvanizing is duplex coating, i.e. the combination of a galvanic zinc layer with an supplemental reactive sealer the zinc in a first period. The equivalence in the protection offered by duplex coating and by HDG has been demonstrated on numerous occasions at Hilti test facilities around the world as well as at independent external labs. Duplex coating is applied to many Hilti grating fasteners, X-FCM-M.

**Mechanical zinc plating:**

Another alternative to hot dip galvanizing is mechanical plating. In this process, the zinc layer is built from zinc powder that is mechanically pressed onto the surface of the parts to protect. The equivalence in the protection offered by mechanical zinc plating and by HDG has been demonstrated on numerous occasions at Hilti test facilities around the world as well as at independent external labs.

Mechanical plating is applied on some Hilti nails and pins used in direct fastening.

**Hydrogen embrittlement:**

Hydrogen embrittlement is a specific corrosion phenomenon of zinc plated DX fastening elements, which will occur if three different conditions are present simultaneously:

- High strength carbon steel (>1000 MPa)
- Presence of hydrogen
- Tensile stresses

The combination of these three parameters leads to a decrease in the material's ductility, which may cause a sudden fastener failure even under very low static load.

The strength of fasteners is a function of its design and of the acceptable load in each application. Therefore, it is important to control the presence of hydrogen in the fasteners to prevent embrittlement from occurring. There are two main sources of hydrogen for zinc plated fasteners:

- The production process (primary hydrogen embrittlement): Hilti's power actuated fasteners are thoroughly tested and controlled during the production process to prevent primary hydrogen embrittlement.
- The corrosion process in the application (secondary hydrogen embrittlement): When zinc plated, high-strength fasteners are used in wet atmosphere, hydrogen is formed by the chemical reaction of zinc and water and diffuses into the material. To avoid secondary hydrogen embrittlement during the service life of a fastener, it is essential to follow the recommended application conditions provided for each nail in Hilti technical documents.

### Stainless steel

Stainless steel comes in many different types, each of which has different corrosion resistance properties. A stainless steel material used in a wrong environment can lead to pitting corrosion and, subsequently, sudden fastener failure. In such a situation, predicting a fastener's lifetime is not possible.

Hilti power actuated fasteners are manufactured using CR500 and 1.4462 material, similar to A4 (AISI grade 316), which offers high performance in a wide range of applications.

For higher corrosion requirements, fasteners made out of HCR (1.4529) material can be provided. The HCR (High Corrosion Resistance) material can be used in swimming pools and in road tunnels, where the performance of A4 material is not sufficient.

Stainless steel with pitting corrosion, e.g. A4 material used in a road tunnel



Suitable stainless steel used, e.g. HCR material used in a road tunnel

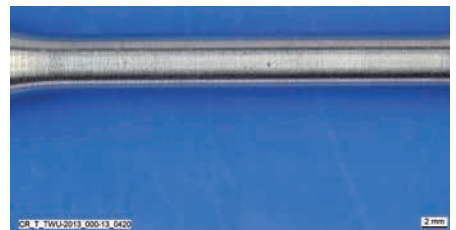

### 4.2 Fastener selection

Following table (next page) gives a general guideline of commonly-accepted applications in typical atmospheric environments. Suitability of fastening systems for a specific application can be significantly affected by localized conditions, including but not limited to:

- Elevated temperatures and humidity
- High levels of airborne pollutants
- Direct contact with corrosive products, commonly found in chemically-treated wood, waste water or salt water, concrete additives, cleaning agents, etc.

- Non-atmospheric corrosion like e.g. direct contact to soil, stagnant water
- Cyclical wetting
- Electrical current
- Contact with dissimilar metals
- Physical damage or wear

Environmental conditions		Fastened part		Carbon steel		Stainless steel	
				Fastener		Examples	
				Galv. zinc coating	Duplex coating	CR500 or 1.4462 (A4, AISI 316)	HCR 1.4529
				X-ENP <sup>1)</sup> , X-U, X-GHP	X-FCM-M	X-BT, X-CR	On demand
		Dry indoor	steel (zinc coated, painted), aluminum, stainless steel, wood	■	■	■	■
		Indoor with temporary condensation	steel (zinc coated, painted), aluminum, stainless steel, wood	Consult experts for exceptions	■	■	■
		Outdoor, non-safety relevant <sup>2)</sup>	steel (zinc coated, painted), aluminum, wood	■	■	■	■
		Outdoor, rural or urban environment with low pollution	steel (zinc coated, painted)	—	■	■	■
			aluminum, stainless steel	—	Consult experts for exceptions	■	■
		Outdoor, rural or urban environment with moderate concentration of pollutants and/or salt from sea water	steel (zinc coated, painted)	—	Consult experts for exceptions	■	■
			aluminum, stainless steel	—	Consult experts for exceptions	■	■
		Coastal areas	steel (zinc coated, painted), aluminum, wood	—	—	■	■
	0-1 km	Outdoor, areas with heavy industrial pollution	steel (zinc coated, painted), aluminum, wood	—	—	■	■
	0-10 m	Close distance to streets	steel (zinc coated, painted), aluminum, wood	—	—	■	■
	Special applications	Road tunnels, indoor swimming pools, special applications in chemical industry	steel (zinc coated, painted), aluminum, wood	—	—	Consult experts for exceptions	■

■ = expected lifetime of power actuated fasteners made from this material is typically satisfactory in the specified environment based on the typically expected lifetime of a building. The assumed service life in ETA approvals for power actuated fasteners is 25 years.

— = fasteners made from this material are not suitable in the specified environment. Exceptions need a specific assessment.

1) Outdoor exposure for up to 6 months during construction is permissible for high-strength electro-galvanized siding and decking fasteners such as the X-ENP (see instructions for use for details)

2) The reference to “non-safety relevant” is intended to distinguish applications where failure of the attachment will not create any potential safety risks or significant damage.

## Remarks:

- The ultimate decision on the required corrosion protection must be made by the customer. Hilti accepts no responsibility regarding the suitability of a product for a specific application, even if informed of the applications conditions.
- This table is based on an average service life for typical applications.
- For metallic coating e.g. zinc layer systems the end of life time is the point where red rust is visible over a large percentage of the product and widespread structural deterioration can occur – the initial onset of rust will occur much sooner
- National or international codes, standards or regulations, customer and/or industry specific guidelines must be independently evaluated.
- These guidelines apply to atmospheric corrosion only. Other types of corrosion, such as crevice corrosion or stress corrosion cracking must be independently evaluated.

A typical service life of Hilti GX-WF nails in wood - wood connections is shown below:

Service Classes in accordance with EN 1995 (Eurocode 5):		Service Class 1	Service Class 1,2	Service Class 1,2,3			
Type of Corrosion Protection for Hilti GX-WF wood nails (d ≤ 4mm):		No Corrosion Protection	Zinc coated	HDG	A2 <sup>1)</sup>	A4	
		Dry indoor	20 to 50 years	up to 50 years	up to 100 years	■	■
		Indoor environments with temporary condensation	—	10 to 50 years	60 to 100 years	■	■
		Outdoor with low pollution	—	5 to 20 years	40 to 100 years	■	■
		Outdoor with moderate concentration of pollutants	—	2 to 10 years	20 to 40 years	■	■
		Coastal areas	—	up to 5 years	10 to 30 years	—	■
		Outdoor, areas with heavy industrial pollution	—	up to 5 years	10 to 30 years	—	■
		Close distance to streets	—	—	—	—	■
	Special applications	Special applications	Consult experts for exceptions				

The table above provides typically assumed service life estimations based on corrosion considerations. Other factors determining the service life of fasteners must be evaluated separately.

- = expected lifetime of nails made from this material is typically satisfactory in the specified environment based on the typically expected lifetime of a building.
- = nails made from this material are not suitable for the environment or the typical lifetime of a building is not achieved.

1) For nails made of A2 material, discoloration of nail heads can occur before the service life in the table above is reached. To avoid this, use A4 material.

**Remarks:**

- The use of certain wood species including, but not limited to, Oak, Douglas-fir or Western Red Cedar, require the use of stainless steel nails, independent of Service Class and environmental conditions.
- The use of certain wood treatments including, but not limited to, fire retardants or preservatives can change the chemical composition of the wood and may require the use of stainless steel nails, independent of Service Class and environmental conditions.
- The evaluation of corrosive environmental conditions depends on many factors and lies within the responsibility of the customer. The planned service life of the buildings or structures can be considered according to local or national building regulations and Eurocode (EN 1990)
- The table does not contain recommendations and Hilti does not assume liability for fastener selection based on its content.
- For the typical service life, it is assumed that the nails are selected, designed, installed and otherwise treated in accordance with Hilti's published literature.
- Local building regulations and trade rules may differ from the table above. The local jurisdiction always needs to be followed.
- Wood to steel connections may require a minimum corrosion protection, independent of the environmental conditions.

## 5. Steel base material

### 5.1 Anchoring mechanisms

The following four mechanisms cause a fastener to hold when driven into steel:

- clamping
- keying
- fusing (welding)
- soldering

These mechanisms have been identified and studied by analyzing pull-out test data and by microscopic examination of fastening cross-sections.



#### Clamping

As a fastener is driven, the steel is displaced radially and towards both the entry and opposite surfaces. This results in residual pressure on the surface of the nail, which leads to friction or clamping. Clamping is the primary anchoring mechanism of through-penetrating fasteners. This is indicated by the fact that when through-penetrating fasteners are extracted, the pull-out force decreases only slowly over several millimeters of displacement.

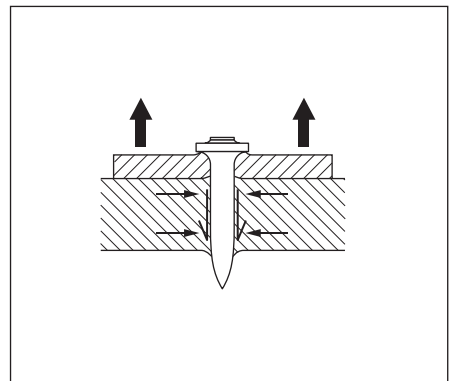

#### Keying

The keying mechanism is possible when the fastener is knurled, that is, it has fine grooves along the shank in which zinc and particles of base steel accumulate during the driving process. Microscopic examination of cross sections has shown that the grooves are not completely filled. Keying is an especially important anchoring mechanism for fasteners that do not penetrate right through the base material.

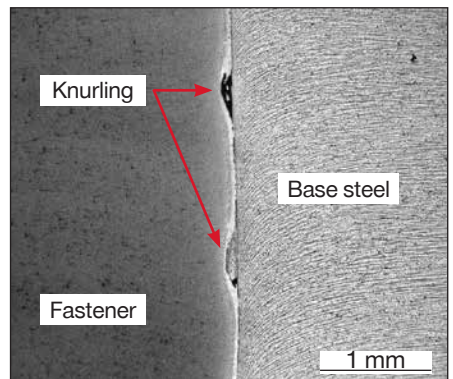

### Fusing (welding)

Complete fusing of the fastener with the base steel is indicated by portions of base material clinging to the extracted fastener. Fusing or welding is observed mostly at the point of a fastener where the temperature during driving can be expected to be the highest.

For fasteners that do not through-penetrate, this is an important anchoring mechanism. It can be relied upon only if the fastener point is manufactured without cracks and with an appropriate geometry. The thermo pulling process is ideal for achieving an optimized geometry. Control of all steps in the production process is necessary to avoid

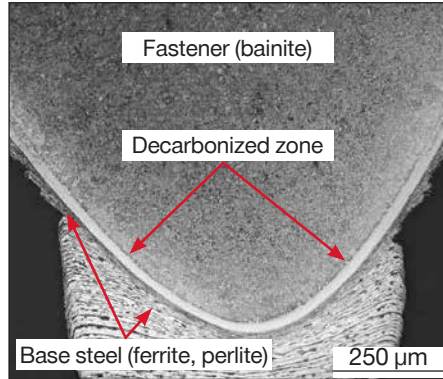

cracks in the point.

### Soldering

In the zone further from the point, there is a prominent zinc layer separating the fastener from the base steel. This zinc, soldered to the base steel, also makes a contribution to the pull-out resistance of the fastener.

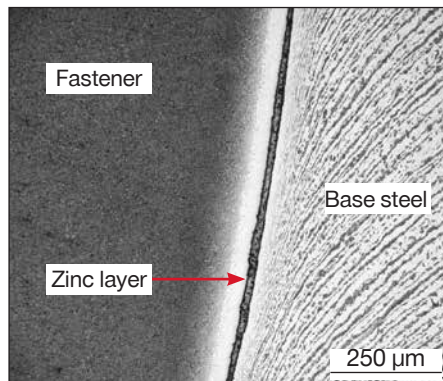

### Blunt-tipped fastener X-BT family

The X-BT fastener with a shank diameter of 4.5 mm is driven in a pre-drilled 4.0 mm diameter hole. This leads to displacement of the base material. Part of the base steel is punched down into the pre-drilled hole, generating high temperatures and causing friction welding. Due to elasticity of the base steel, additional clamping effects are also superposed.

Displaced base material can be clearly seen in the photograph. Base material adhering to the fastener shank indicates a welding effect.





## 5.2 Factors influencing pull-out resistance

Powder-actuated fastening systems must be designed and manufactured to ensure that pull-out resistance will be adequate for the applications intended. Through understanding of the anchoring mechanisms, experience and testing, factors that influence pull-out strength have been identified. Some of these factors are:

- Depth of penetration in the base material
- Surface characteristics of the fastener
- Coatings on the steel base material
- Driving velocity
- Diameter of the fastener shank

Knowledge of the influencing factors is vital to the design of fastening systems and is useful for operators in understanding the various application guidelines and restrictions that apply to a fastening system. Some of the influencing factors are discussed in the following section.

### Depth of penetration in the base material

The depth of penetration of fasteners in steel is taken as the distance that the point travels below the surface of the base steel, independent of the steel thickness. In other words the depth of penetration  $h_{ET}$  can be greater than, equal to or less than the steel thickness.

Resistance to pull-out increases with increasing depth of penetration. This is also true for through-penetrating fasteners where  $h_{ET}$  is greater than the steel thickness. The design of a powder-actuated fastener has to take into account the depth of penetration necessary to achieve the pull-out resistance required for the application. Application guidelines published for any fastener include the required nail head stand-off  $h_{NVS}$ , which corresponds to the penetration depth.

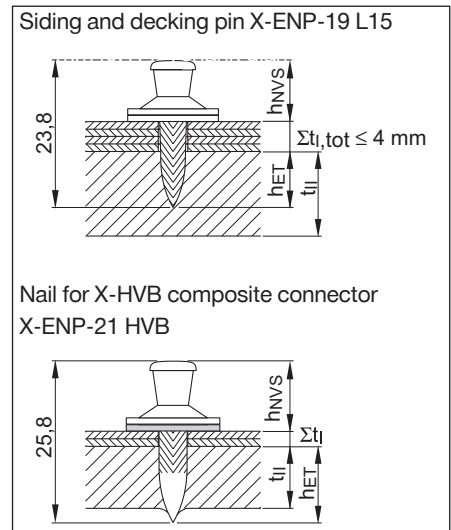

Guide values for the depth of penetration of specific fastener types are as follows:

- Galvanized fastener with knurled shank:  $h_{ET} = 12$  to  $18$  mm (shank diameter 4.5 mm)
- Galvanized fastener with knurled tip:  $h_{ET} = 10$  to  $14$  mm (shank diameter 3.7 mm)
- Galvanized fastener with knurled tip:  $h_{ET} = 9$  to  $13$  mm (shank diameter 4.5 mm)
- Galvanized fastener with smooth shank:  $h_{ET} = 15$  to  $25$  mm
- Stainless steel fastener with smooth shank:  $h_{ET} = 9$  to  $14$  mm
- Blunt-ended fasteners:  $h_{ET} = 4$  to  $5$  mm

The effect of penetration depth on pull-out strength can be demonstrated in experiments in which the driving energy is varied so as to produce varying penetration. The results of a test of this kind are summarized below. The application recommendations for fasteners are based on tests like these and they clearly show the importance of carrying out the fastening installation in accordance with the recommendations of the manufacturer.

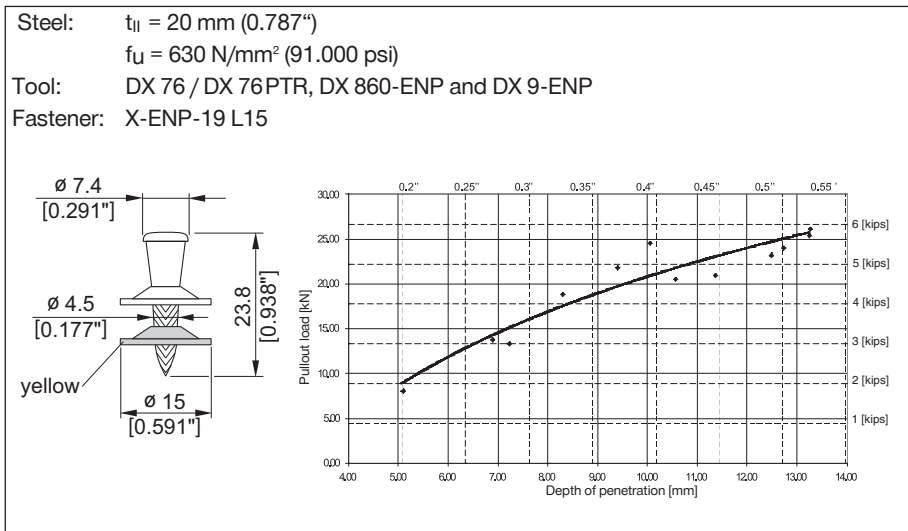

### Knurling on the fastener shank

Fasteners for use in steel base material usually have knurling on the shank so as to improve the resistance to pull-out. The effect of the knurling was shown in a test with fasteners that had knurled and unknurled shanks, but were otherwise the same.

The benefit of knurling is clearly seen from the test results. With virtually the same penetration (actually 106%), the smooth-shank fastener had only 68% of the pull-out strength of the knurled-shank type. Even with the penetration increased to 137%, the pull-out strength was still only 81% of that of the knurled-shank fastener. In this test, the steel thickness of 10 mm (0.394") allowed through penetration of the steel. If the steel is too thick for through penetration, the beneficial effect of knurling becomes even more pronounced.

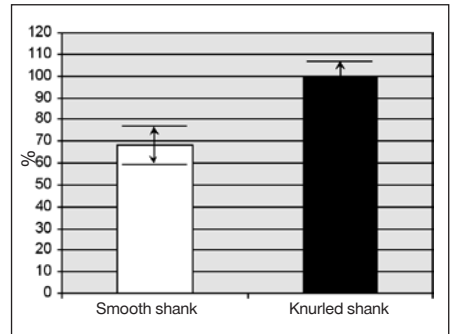

### Zinc coating on the fastener shank

Zinc on a fastener shank appears to act as a lubricant that reduces its resistance to penetration into steel. Reduced pull-out strength is the result, because the lower resistance means less heat is generated, thus reducing the welding effect between the shank and the base steel. This was shown in an experiment with fasteners that were identical except for the thickness of zinc coating.

Steel base material:  $t_{II} = 20 \text{ mm [0.787"]}$ ,

$f_u = 440 \text{ MPa [63,817 psi]}$

Zinc thickness in mm	Average penetration		Average ultimate pull-out load		Variation CV %
	$h_{ET}$ mm / [in.]	%	$N_{u,m}$ kN / [kip]	%	
ca. 10	12.12 [0.477]	100	8.53 / [1.918]	67	25.6
2-5	11.86 [0.470]	98	12.82 / [2.882]	100	9.3

Although driving the fastener through sheet metal, as is the case when fastening siding and decking, reduces the negative effect of zinc coating on pull-out strength, the reason for tightly controlling the galvanization process is clear.

### Surface of the steel base material

Corrosion protection of structural steel is often achieved by hot-dip galvanizing. Tests have shown that if the fastener penetrates right through the steel, the galvanizing has no significant effect on pull-out strength. In the case of fasteners that do not through-penetrate, pull-out strength is reduced by about 25%. The summary of results from one test is shown below to illustrate these effects.

### Average ultimate pull-out loads

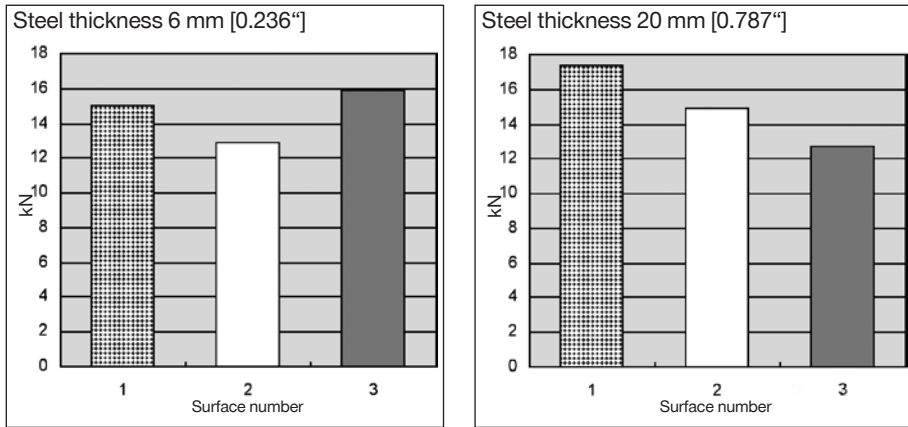

Ultimate tensile strength of steel :  
Surface of the steel :

$f_u = 430 \text{ MPa [62,366 psi]}$   
1. Rough with some slag and rust (reference)  
2. Sandblasted  
3. Pickled + hot-dip galvanized (min. 60  $\mu\text{m}$  zinc)

Several important observations can be made based on these results:

- Pull-out loads in 6 mm ( $1/4"$ ) steel base material are much less affected by the surface condition of the steel than they are in 20 mm ( $3/4"$ ) steel. The reason is that the main anchoring mechanism of through-penetration fastenings is clamping, which is not affected by the surface condition of the steel.
- Hot-dip galvanizing appears to reduce the pull-out strength of non-through-penetrating fastenings by nearly 30%. Note, however, that even with hot-dip galvanizing, the pull-out strength was still 12.5 kN (2.8 kips).

• The negative effect of hot-dip galvanizing is explained by the tendency of zinc on the fastener to act as a lubricant that reduces heat generation during driving. This in turn reduces the tendency of the fastener point to fuse to the base steel. Zinc from the coating on the base steel apparently becomes attached to the fastener as it enters the base steel.

For applications where tensile strength of the fastening is critical and the steel has a heavy coating, the fastening system can be qualified by carrying out pull-out tests on site. If pull-out strength is not adequate, depth of penetration can be increased to improve the situation.

### Tensile stress in the steel

The integrity of a powder-actuated fastening is dependent on a relatively smooth pin remaining anchored in structural steel. A large amount of test data, technical assessments, approvals and practical experience with powder-actuated fastenings is available to support use of powder-actuated fastening. Performance of fasteners anchored in the steel under tension was investigated by driving fasteners into unstressed steel plates and extracting them with the plates stressed in tension. The steel plates measured 6x80x455 mm [0.236" · 3.15" · 17.9"] and possessed two different yield stresses - 328.6 MPa [47.7 ksi] and 411.7 MPa [59.7 ksi].

By expressing the steel stress in terms of % of actual yield, it was possible to combine the data for both steel grades and obtain a reasonable curve fit.

Of significance to the designer is the expected decrease in pull-out strength of the fastener at a typical maximum allowable design stress of 60 to 70 % of yield. At this stress, the pull-out strength reduction is less than 15%. The absolute value in the experiment was still greater than 2 tons.

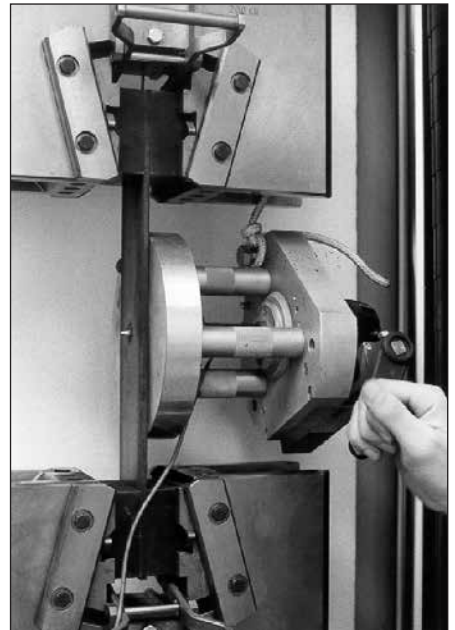
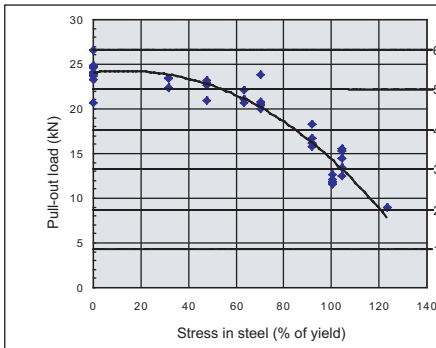

### Compressive stress in the steel

Compressive stress in the base steel has no influence on the pull-out strength of the fastener. This was demonstrated by placing fasteners in unstressed 15 mm [0.59"] thick steel plates having a yield strength of 259.3 MPa [37.6 ksi] and extracting them while the plates were compressed in a testing machine.

The minimal variation in pull-out load is simply random variation experienced in testing.

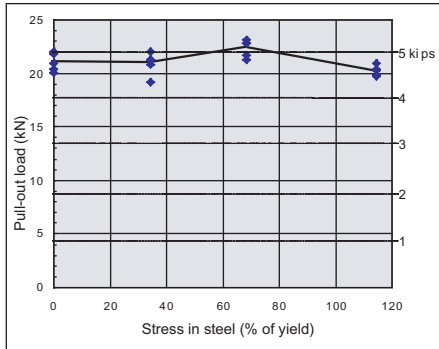

### 5.3 Suitability of the steel for fastening

There are three main factors determining the suitability of a construction grade steel member for DX fastening:

- Steel thickness
- Ultimate tensile strength
- Flexibility of the base steel member

### 5.4 Application limit diagrams

The application limit of a fastening system is a term applied to a combination of the maximum thickness  $t_{II}$  and ultimate tensile strength  $f_u$  of steel in which fastenings can be made. There are two general types of application limit diagrams:

- Short fasteners (e.g. siding and decking nails and threaded studs)
- Long fasteners (e.g. nails used to fasten wood to steel)

The application limit line for a short fastener is a plot of steel thickness versus ultimate tensile strength. In situations represented by steel thickness / ultimate tensile strength combinations above and to the right of the line, some of the fasteners may shear off during driving. The failure surface will be roughly at a 45° angle to the shank length.

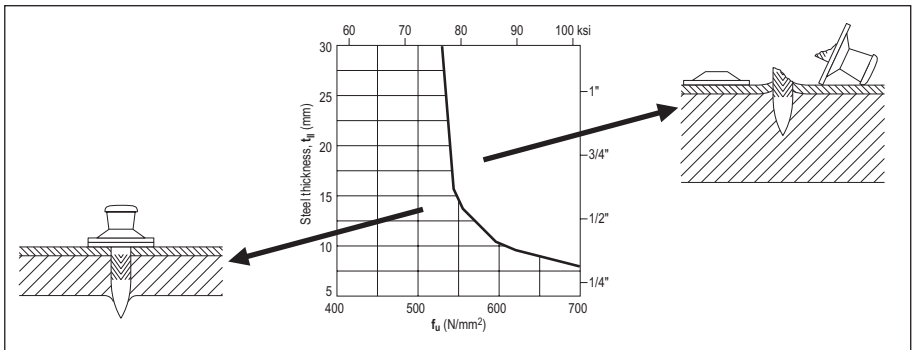

The application limit lines for long nails used to fasten wood to steel are plots of nail shank length  $L_s$  versus steel thickness  $t_{II}$ . Each line is valid only for one ultimate tensile strength of steel  $f_u$ . Attempts at working to the right of the limit line result in buckled nail shanks.

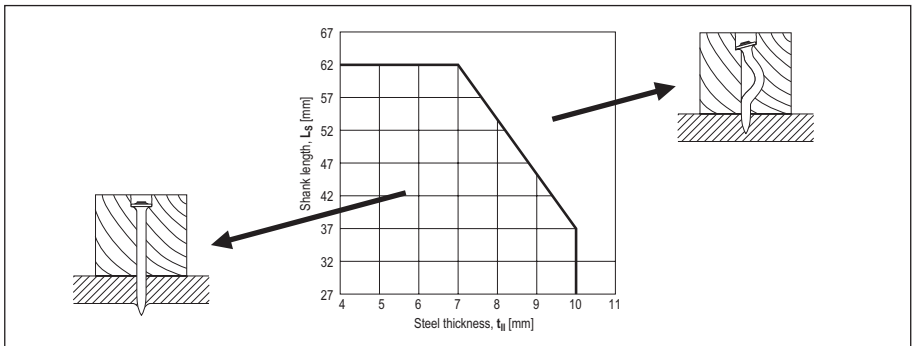

### 5.5 Thin steel base material

In the context of powder-actuated fastening, steel is considered thin when flange deformation during driving dominates fastener design. When the steel flange is thinner than about 6 mm [0.25"], flange deformation makes use of fasteners with a 4.5 mm [0.177"] shank diameter more difficult and switching to a 3.7 mm [0.145"] shank fastener leads to better results. Use of fasteners with tapered shanks and energy-absorbing washers improves performance and reliability.

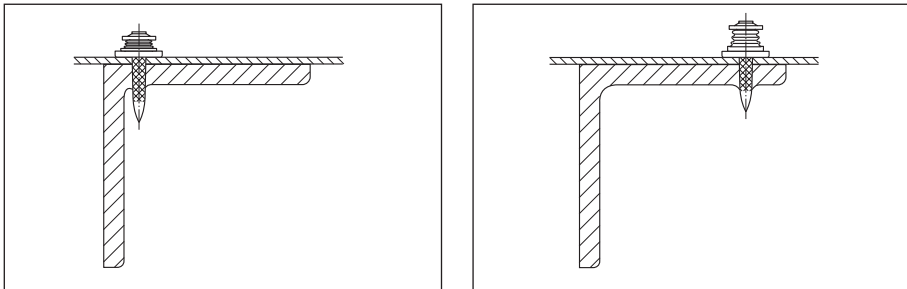

A fastener can penetrate into steel only when the steel (flange) develops a resistance greater than the force required for penetration. This implies the use of energy in excess of that required for penetrating into the steel. In fact, if the driving energy remains constant, fasteners placed closest to the web will be driven deepest. All siding and decking fasteners should have a mechanism to clamp the sheets down tightly over the entire range of allowable standoffs. This is especially critical for fasteners used for fastening to thin steel.

Obviously, under shear loading, failure of the base material is more likely with thin steel than with thick steel. When approving fastening systems for a project, it is important to consider whether the system has actually been tested with thin base steel or not.

Hilti's general recommendation for thin base steel fasteners is to place the fastenings within  $b_x = 8 \cdot t_{fl}$  of the web.

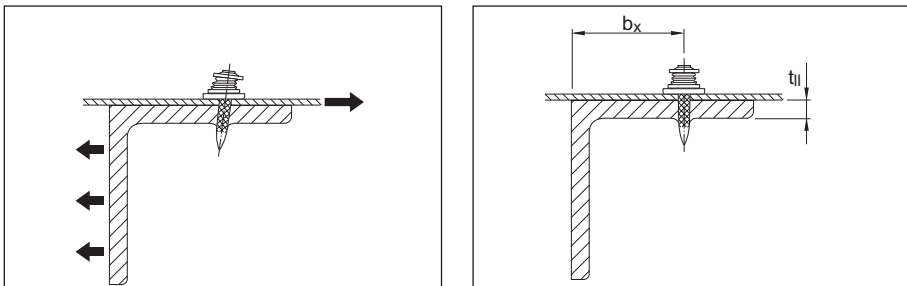



## 5.6 Types of load and modes of failure

### 5.6.1 Shear loads

The shear loads acting on siding and decking fasteners come from:

- Diaphragm action of the fastened sheets
- Forces of constraint (for example due to temperature changes)
- Self-weight of siding material

### Testing

Shear testing of siding and decking fastenings is done using specimens made up of a strip of sheet metal fastened to a steel plate. Suitable, non-slip fixtures have to be used at either end. In some cases specimens are bent up at the sides to hinder eccentricity.

### Failure of the fastened material

The load-deformation curves of shear tests with powder-actuated fasteners show a nearly ideal behavior. After an initial elastic phase during which the clamping force of the washers against the sheet metal is overcome, the sheet metal reaches its yield stress in an area where the fastener bears against it. Then the fastener shank cuts through the sheet metal until the end of the sheet is reached. The large area under the load-deformation curve represents energy absorbed, and this is what makes the fastening method ideal for diaphragms.

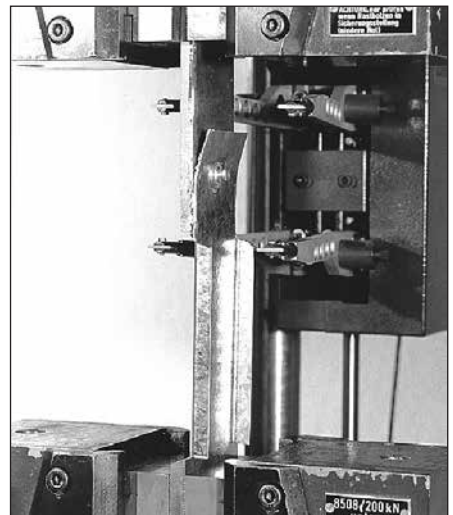

### Failure of the base steel

If the thickness of the fastened sheet metal is large compared to the base steel thickness, bearing failure of the base material is a possible mode of failure.

### Pull-out from the base steel

The unavoidable eccentricity in the shear test specimen leads to a tensile load component on the fastener. Thick fastened material and thin base material is also involved in this mode of failure. This failure mode is generally not governing for base material thickness of  $t_{II} > 6$  mm.

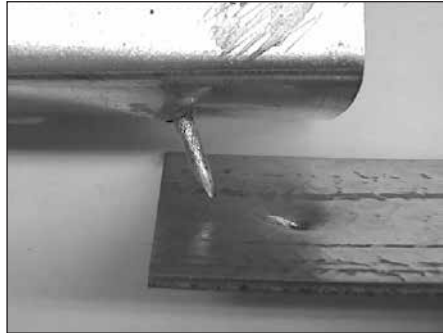

### Fracture of the fastener

About 20 kN (4.5 kips) of force is required to shear the  $\text{Ø } 4.5$  mm (0.177") shank of an X-ENP-19 L15 fastener. With about 2.5 mm (12 gauge) thick steel sheet as fastened material, a force of this magnitude could be possible. The force needed to break a  $\text{Ø } 3.7$  mm (0.145") shank of an X-ENP2K-20 L15 fastener is about 13 kN (2.9 kips). This force can be generated with 1.5 mm (16 gauge) sheet steel. In practice, this failure mode is likely only where expansion joints are not provided to relieve forces of constraint from temperature differences.

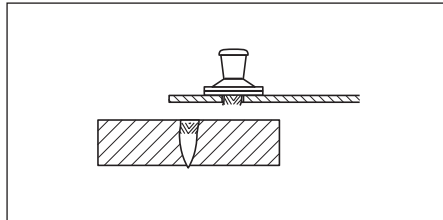

## 5.6.2 Tensile loads

The most common source of tensile loading on siding and decking fasteners comes from wind suction acting on the roof or wall cladding. In diaphragms, fasteners can be subject to tensile loads in situations where the combination of geometry and thickness of decking fastened leads to prying. In designs with very stiff decking and wide beams or unbalanced spans, prying can also be caused by concentrated loads.

## Testing

Tensile testing of siding and decking fastenings is carried out using specimens made up of a trapezoidal-shaped piece of sheet metal fastened to a steel plate. Suitable, vice-like fixtures are used to grip the specimen. This is often referred to as a pull-over test because the common failure mode is the sheet pulling over the washers or the head of the fastener. If the sheet thickness fastened is increased so that pull-over does not govern, pull-out will be the failure mode.

Some fasteners like the Hilti X-ENP have a head that can be gripped and pulled out by a suitable fixture. With these fasteners, a pull-out test can still be done even if pull-over is the original mode of failure. This fastener type has the further advantage of allowing in-place fasteners on a jobsite to be tested.

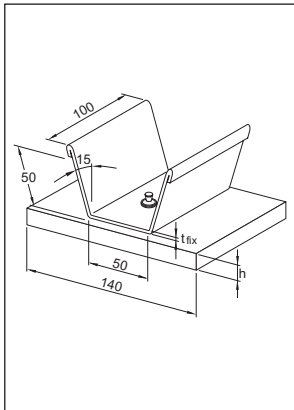

Pull-over test specimen

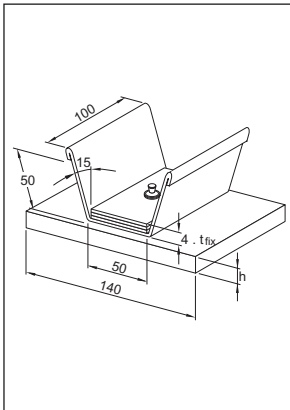

Pull-over test specimen with 3 extra layers to simulate end lap – side lap



Test setup

## Sheet pull-over

In this failure mode, the sheet tears and is lifted up over the fastener head and washers. Depending on the sheet thickness and tensile strength, the washers may be bent up.

## Washer pull-over

Another possible failure mode is that of the washers being pulled up over the head of the nail. Obviously, this happens when the sheet is somewhat stronger and /or thicker than when sheet pull-over occurs. This failure mode is also heavily dependent on fastener design.

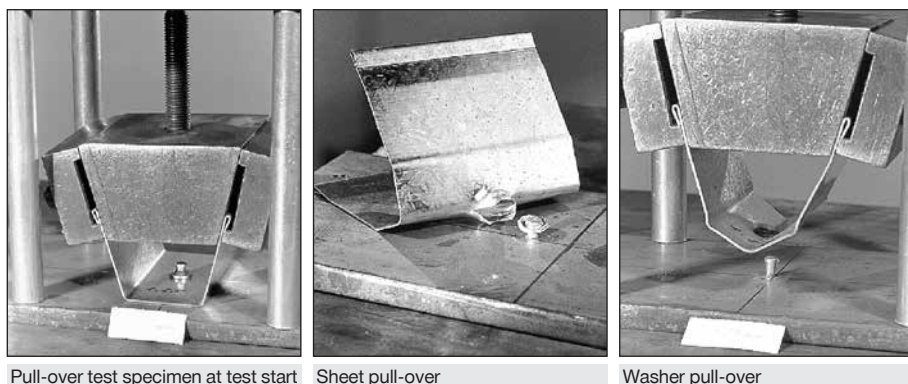

### Pull-out from the base steel

As sheet thickness and number of layers is increased, this failure mode becomes more likely. For a properly driven **X-ENP-19 L15** pull-out from the base steel is not a likely mode of failure. The head and washer design of the **HSN 24** or **X-ENP2K-20 L15** fasteners can allow this failure mode, especially with multiple layers of sheets.

### Fracture of the fastener

A force of more than 30 kN [6.7 kips] is required to break the  $\varnothing 4.5$  mm [0.177"] shank of an **X-ENP-19 L15** fastener and, even if sheet or washer pull-over does not govern, pull-out strengths of this magnitude are not very common. This mode of failure will therefore hardly ever occur with these heavy-duty fasteners. The  $\varnothing 3.7$  mm [0.145"] shank of an **X-HSN 24** or **X-ENP2K-20 L15** fastener may break at about 20 kN [4.5 kips] tension. Since these smaller fasteners will pull out at a force of 8 to 15 kN [1.8–3.3 kips], fractures due to tensile loads are rare. If fractured fasteners of this type are found on a jobsite, the most likely cause is that the application limit has been exceeded (the base steel is too hard and/or too thick for the pin).

### Cyclic loading

Siding and decking nails used in wall and roof construction are subject to cyclic loading from wind suction. Cyclic load testing is carried out to determine characteristic resistance and allowable (recommended) loads. The requirements of the European Technical Assessment ETA prepared by DIBt (Deutsches Institut für Bautechnik) govern the design-relevant number of load repetitions (5,000) and the necessary safety factors. Notes in this regard are found on the corresponding product data sheets.

If the fastener will be subjected to a large number of load repetitions and fatigue, we recommend carrying out a design check according to the requirements of Eurocode 3 (or similar code). Eurocode 3 gives the characteristic fatigue resistance and safety concept

for steel construction. To carry out the check according to Eurocode 3 it is necessary to have a statistical analysis of test data obtained under the application conditions. Except for siding and decking fasteners, the applicable product data sheets limit the validity of recommended loads to predominantly static loading. If a design analysis has to be carried out for true fatigue loading, test data can be obtained from Hilti. Examples of such data are shown below.

**X-EM8-15-14**  
**(standard zinc-plated fastener)**

The X-EM8-15-14 has a shank diameter of 4.5 mm and a hardness of HRC 55.5 ( $f_u = 2,000$  MPa). The  $\Delta F$ -N diagram shows the load range  $\Delta F$  for a lower load of 0.05 kN. The individual test results are displayed as points and the curves show average and characteristic (95% survival probability) values. The failure mode was shank fracture or fracture in the M8 threading.

The recommended load for predominantly static loading is 2.4 kN. Comparing this value to the  $\Delta F$ -N diagram will lead to the conclusion that X-EM8-15-14 fastenings designed for 2.4 kN static loading will survive a large number of load repetitions. The fastenings can be said to be robust, even when the actual loading turns out to be in part cyclic.

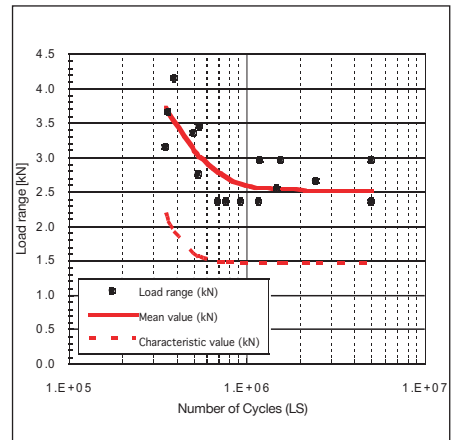

### X-CRM8-15-12 (stainless steel fastener)

The X-CRM8-15-12 has a shank diameter of 4.0 mm and a minimum ultimate tensile strength of 1,850 MPa. The  $\Delta F$ -N diagram shows the load range  $\Delta F$  for a lower load of 0.05 kN. The individual test results are displayed as points. The failure mode was shank fracture or fracture just below the head of the stud.

The recommended load for predominantly static loading is 1.8 kN. Comparing this value to the  $\Delta F$ -N diagram will lead to the conclusion that X-CRM8-15-12 fastenings designed for 1.8 kN static loading will survive a large number of load repetitions. The fastenings can be said to be robust, even when the actual loading turns out to be in part cyclic.

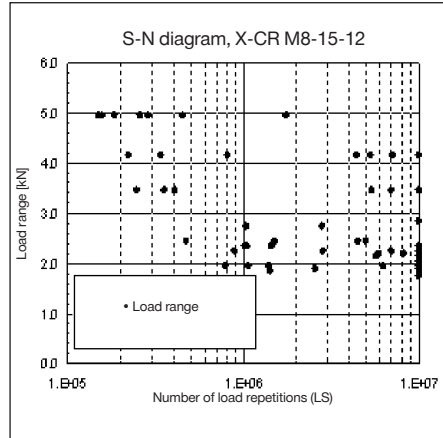

### Mode of failure under cyclic loading

A major finding of cyclic loading tests is that the strength of a DX fastening subject to cyclic loading is not limited by failure of the anchorage. It is only when the number of cycles is very low – i.e. predominantly static loading – that nail pull-out is observed. The two schematic diagrams below show the relationship between failure mode and number of cycles. All tests show that the anchorage of DX fasteners in steel and in concrete is extremely robust with regard to resisting cyclic loading. Fasteners subject to a large number of load repetitions fracture in the shank, head or threading. A condition for obtaining this behaviour is that the fasteners are correctly driven. Fasteners that are not

driven deeply enough exhibit low pull-out strength and in a cyclic loading test may not necessarily fail by fracture.

Effect of number of cycles on failure mode DX fastener in steel (correctly placed)

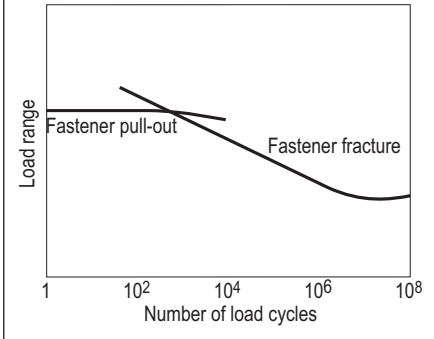

Effect of number of cycles on failure mode DX fastener in steel (incorrectly placed)

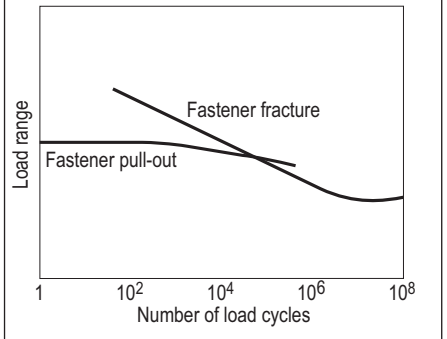

In older product information and data sheets, this basic suitability of DX fasteners for cyclic loading was emphasized by defining the recommended loads as cyclic recommended loads. At the time that this product information was assembled, a true safety concept for a strict check of DX fastenings subject to fatigue loading was not available. With Eurocode 3, this is today available. If a fatigue design analysis is carried out, it is important – as with static design – that adequate redundancy be provided.

### Failure of the sheet

In cyclic load tests, failure of the steel sheet itself is common.

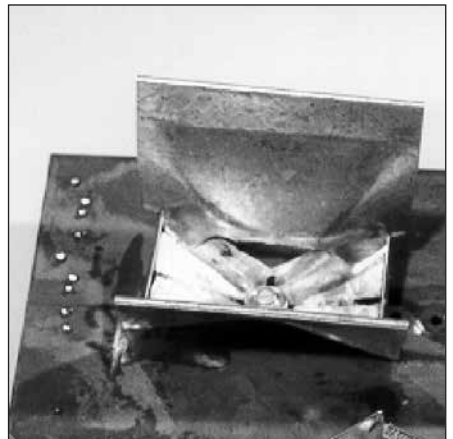

## 5.7 Effect of fasteners on structural steel

Driving powder-, gas-, or battery-actuated fasteners into a steel member does not remove steel from the cross-section, but rather displaces steel within the cross-section. It is therefore not surprising that tests like those described in following sections show that both drilled holes and screws, either self-drilling or self-tapping, reduce the strength of a cross-section more than powder-actuated fasteners.

The results of the tests can also be used to show that it is conservative to consider a powder-actuated fastener as a hole. This allows the effect of fasteners in a steel member subject to static loading to be taken into consideration.

Fatigue seldom needs to be considered in building design because the load changes are usually minor in frequency and magnitude. Full design wind and earthquake loading is so infrequent that consideration of fatigue is not required. However, fatigue may have to be considered in the design of crane runways, machinery supports, etc. The S-N curves resulting from fatigue tests of steel specimens with fasteners installed are also presented.

### 5.7.1 Effect on the stress-strain behaviour of structural steel

The effect that powder-actuated fasteners (PAF's) have on the stress-strain behaviour of structural steel was investigated in a systematic test programme using tensile test specimens containing PAF's, self-drilling screws and drilled holes. A control test was carried out using specimens without any holes or fasteners.

#### Series A:

- ASTM 607, grade 50
- Cross-section 3.42 x 74 mm [0.135 x 2.913"]
- X-EDNK22 powder-actuated fasteners, shank diameter 3.7 mm [0.145"]
- Drilled holes, diameter 3.7 mm [0.145"]
- Self-drilling screws, shank diameter 5.5 mm [0.216"]

#### Series B:

- S235 and S355 steel
- Cross-section 6 x 45 mm [0.236 x 1.772"]
- Powder-actuated fasteners, shank diameter 4.5 mm [0.177"]
- Drilled holes, diameter 4.5 mm [0.177"]



The figures below show representative stress-strain curves for the tests (the plotted stress is based on the gross cross-section). Note that the line for the powder-actuated fasteners follows the control test line more closely than the lines for drilled holes or self-drilling screws.

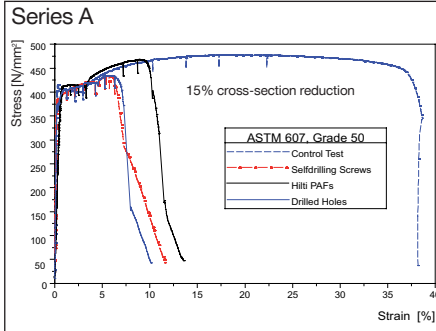

LOAD\_DEFORMATION\_SERIES\_A

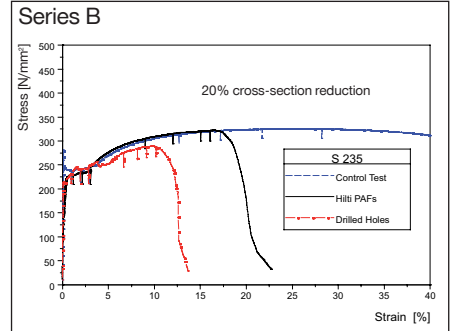

LOAD\_DEFORMATION\_SERIES\_B

The test results were evaluated in terms of utilization as a measure of ultimate strength. Utilization is the ultimate load of a sample expressed as a percent of the ultimate load of the control test.

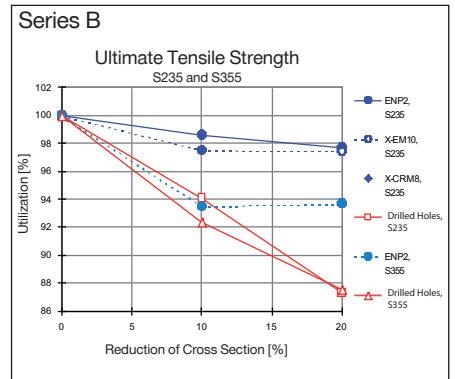
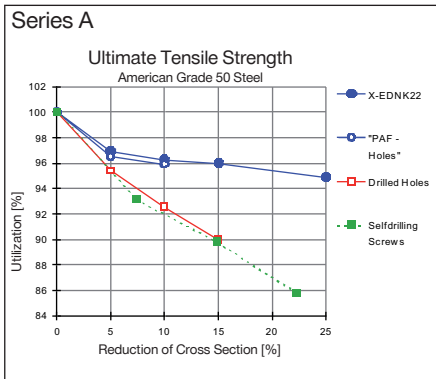

Graphs of the utilization versus cross-section reductions show that:

- The utilization for PAFs is clearly better than that of drilled holes or self-drilling screws.
- The hole left by a removed PAF has the same effect as when the PAF is left in place.
- Increasing the number of PAFs across a section from one to two or more has a proportionally smaller effect on utilization than placement of the first fastener.

More detailed information on the test program and findings is published in the paper

Powder-actuated fasteners in steel construction (and the referenced literature), published in the STAHLBAU-Kalender 2011 (Publisher Ernst & Sohn, 2011, ISBN 978-3-433-02955-8). English Reprints of the paper can be distributed per request.

### 5.7.2 Effect on the fatigue strength of structural steel

During the late 1970s and early 1980s, a fatigue testing program consisting of 58 tests with over 1,100 specimens was carried out at the University of Darmstadt in Germany. The reason for the research at that time was to support the use of powder-actuated fasteners for attaching noise-dampening cladding to railway bridges in Germany.

Parameters investigated in those tests are shown in following table:

Steel grade	Steel thicknesses	Stress ratio R	Imperfections
S 235 (St 37) / A36	6, 10, 15, 20, 26.5, 40, 50 mm	0.8, 0.5, 0.14, -1.0, -3.0	Fastener:
S 355 (St 52) / grade 50	[0.236, 0.394, 0.591, 1.043, 1.575, 1.969"]		- installed and pulled out, - inclined installation and pulled out - inclined installation

#### Loading conditions

The terminology and notation is shown in the illustration below.

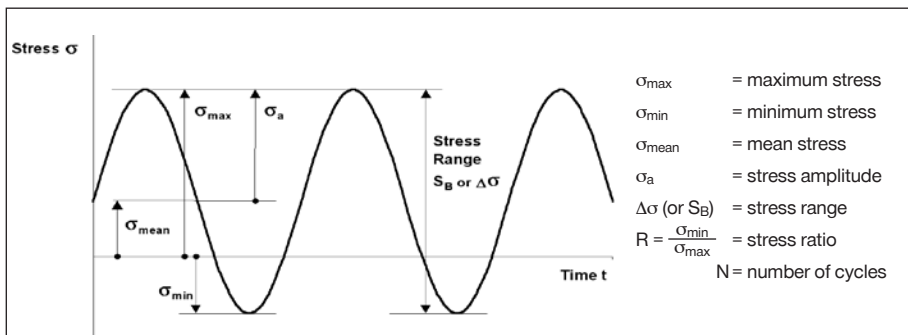

### Fasteners tested

The primary fastener used in the tests was the Hilti ENP3-21 L15, the forerunner of the ENP2-21 L15. The difference is in the head shape, which has no effect on interaction with the base steel. Tests were also performed with the ENP2-21 L15, ENP3-21 D12 and the EM8-11-14 threaded stud, all of which have 4.5 mm diameter knurled shanks.

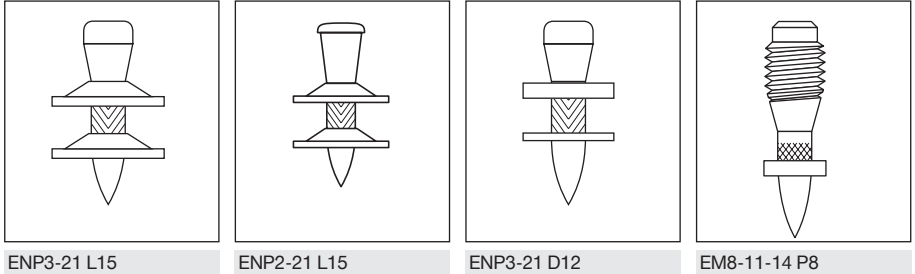

The results of the tests were evaluated by Niessner and Prof. T. Seeger from the University of Darmstadt in accordance with the provisions of Eurocode 3. An example plot of one test series is given at the right. The graph allows for a comparison with European fatigue categories 90 ( $m = 3$ ) and 100 ( $m = 5$ ) as well as American categories according to AWS-provisions.

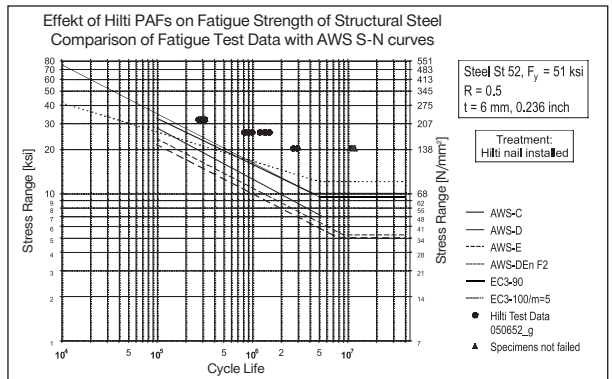

### Conclusions

- The effect of driving a Hilti powder-actuated fastener on the fatigue strength is well known and predictable.
- The constructional detail “Effect of powder-actuated fasteners on base material” (unalloyed carbon steel) was evaluated by Niessner and Seeger from the University of Darmstadt in compliance with Eurocode 3.
- The EC 3 detail category 90 with  $m = 3$  or the detail category 100 with  $m = 5$  is alternatively applicable.
- Wrong fastener installations as popped out or inclined fasteners are covered. Piston marks in the base material due to wrong use of the tool without a fastener or notches due to fasteners failed during the installation have to be removed by appropriate measures.

More detailed information on the evaluation of the test data and the test program is published in the paper “Fatigue strength of structural steel with powder-actuated fasteners according to Eurocode 3” by Niessner M. and Seeger T. (Stahlbau 68, 1999, issue 11, pp. 941-948).

English reprints of this paper can be distributed per request.

## 6. Concrete base material

### 6.1 Anchoring mechanisms

The following three mechanisms cause a powder-actuated fastener to hold in concrete:

- Bonding / sintering
- Keying
- Clamping

These mechanisms have been identified and studied by analyzing pull-out test data and by microscopic examination of pulled-out fasteners and the concrete to fastener interface.

#### Bonding / sintering

When driving a fastener into concrete, the concrete is compacted. The intense heat generated during driving causes concrete to be sintered onto the fastener. The strength of this sintered bond is actually greater than that of the clamping effect due to reactive forces of the concrete on the fastener.

The existence of the sintered bond is demonstrated by examining pulled-out fasteners. The fastener surface, especially in the region of the point, is rough due to sintered-on concrete, which can only be removed by using a grinding tool.

When performing pull-out tests, the most common failure mode is breakage of the sintered bond between the concrete and the fastener, especially at and near the point.



#### Keying

The sintered material forms ridges on the fastener surface. These ridges result in a micro-interlocking of the fastener and the concrete.

This anchoring mechanism is studied by examining pulled-out fasteners under a microscope. As in the case of sintering, keying is primarily active in the region of the fastener point.

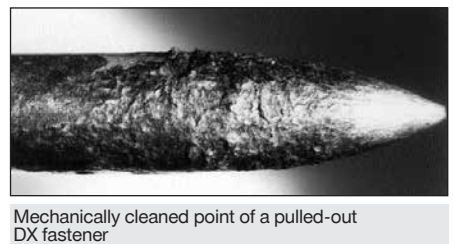

**Clamping**

The compressibility of concrete limits the buildup of compressive stress around the driven fastener. This in turn limits the effectiveness of clamping as an anchoring mechanism.

**Concrete failure**

Concrete cone failure is occasionally observed when using a testing device with widely spaced supports. The fact that the concrete failed indicates that the fastener bond to the concrete was stronger than the concrete.

The tendency of stressed concrete to relax further reduces the compressive stress and hence the clamping effect. For these reasons, clamping of the fastener shank contributes only insignificantly to the total pull-out strength.

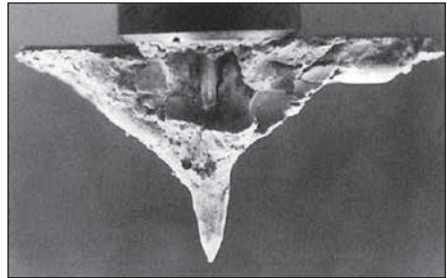

## 6.2 Factors influencing resistance to pull-out

Factors that can affect the pull-out strength of fastenings to concrete include:

- Depth of penetration into the concrete
- Concrete parameter (compressive strength, grain structure, direction of concrete placement)
- Distance to concrete edge and fastener spacing

### Depth of penetration $h_{ET}$

Fasteners that are driven deeper typically have a higher resistance to pull-out. This relation is best shown by placing groups of fasteners with different driving energy and comparing the results for each group with the others. The result of such a test is shown in the graph at the right. Note that fastener driving failures were not considered in calculation of the average ultimate load,  $N_{u,m}$ .

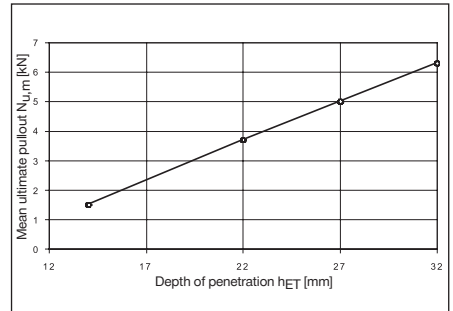

The value of increasing the depth of penetration in order to increase pull-out strength is limited by the increasing fastener driving failure rate. Provided that the penetration depth is the same, fastenings in concrete with a higher compressive strength hold better than fastenings in lower strength concrete. The ability to exploit this

characteristic is also limited by increased fastener driving failure rate with higher strength concrete.

As could be expected, the depth of penetration at which the failure rate is at a minimum decreases with increasing concrete strength.

Pull-out strength and fastener driving failure rate both increase with increasing penetration depth. The optimum depth of penetration is taken as the depth at which the yield in terms of pull-out strength begins to decrease. This is within a range of 18–32 mm depending on the grade and age of the concrete as well as the strength of the fastener.

$$\text{yield} = N_{u,m} \cdot \left( \frac{100 - p}{100} \right)$$

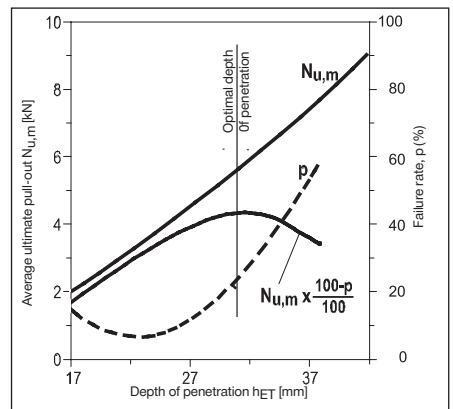

### Concrete parameters

The concrete parameters (such as the type and size of concrete aggregates, type of cement and the location on top or bottom surface of a concrete floor) do affect the fastener driving failure rate, sometimes significantly.

Fastener driving failures are caused by the fastener hitting a hard aggregate, such as granite, located close to the concrete surface. A hard aggregate can deflect the fastener and in a severe case, the fastener may bend excessively,

leading to concrete fracture in a cone shape and no hold being obtained by the fastener.

In case of slight fastener bending, concrete spalling may occur at the surface. However, because pull-out strength is obtained mostly in the area of the fastener point, concrete spalling has little effect on the permissible load of the fastening.

Softer aggregates such as limestone, sandstone or marble may be completely penetrated when hit by the fastener.

Overhead fastening is usually associated with a higher rate of fastener driving failure than floor fastening. This is due to the distribution of the aggregates within the concrete. Large aggregates tend to accumulate at the bottom of a floor slab. At the top, there is a greater concentration of small aggregates and fines.

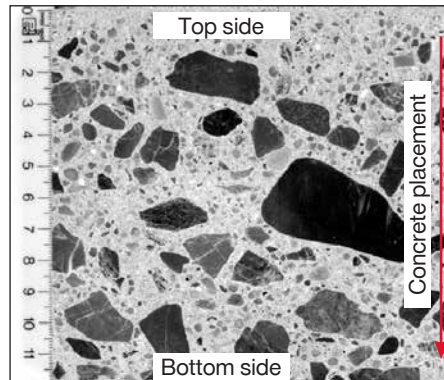



There are several possible ways of reducing the failure rate when powder-actuated fasteners are used for fastening to concrete. There are two basic ideas:

#### **Pre-drilling the concrete (DX-Kwik)**

By pre-drilling a very small hole (5mm diameter, 18 or 23 mm deep), the stresses are relocated to greater depth in the concrete. Fasteners placed with DX-Kwik are surrounded by a stress “bulb” located deep in the concrete. With this method, virtually no fastener driving failures occur.

one is to reduce concrete tensile stresses near the surface and the other is to delay the effect of these stresses.

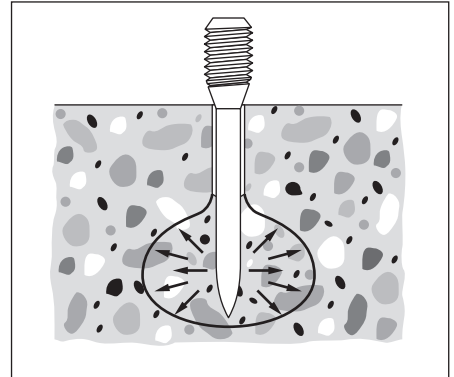

#### **Spall stop fastener guide**

A spall stop is a heavy steel fastener guide. Its weight and inertia counteract the stresses at the surface for a very short time. This allows redistribution of the stresses to other parts of the concrete.

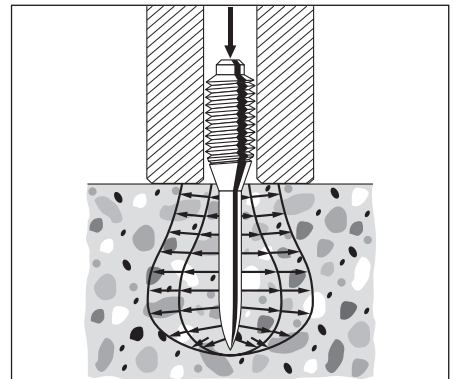

**Changing from a long to a short fastener reduces the magnitude of the stresses and thus improves stick-rate.**

### Edge distance and fastener spacing

If fasteners are placed too close to the concrete edge, pull-out load capacity will be reduced. Minimum edge distances are therefore published with a view to reducing the effect edges have on pull-out strength. The corresponding data has been obtained from tests.

Additional provision is made for fastener spacing when positioned in pairs or where fasteners are placed in rows along a concrete edge.

These edge distances and spacing also have the purpose of helping to prevent concrete spalling and/or cracking due to fastening. However, spalling has generally only an insignificant influence on pull-out strength.

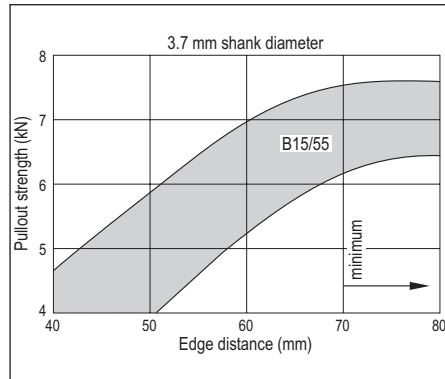

### 6.3 Effect of time on pull-out resistance

The effect of age on pull-out strength has been investigated in comprehensive tests. The main concern is, in fact, the effect of concrete relaxation in the area around the driven fastener.

This graph provides an overview of tests performed with DX-Kwik fasteners. Since standard DX fastenings have the same anchoring mechanism, this statement is also valid for standard DX fastenings. The test results indicate very strongly that relaxation of the concrete has no detrimental effect on the pull-out resistance of DX fastenings. The test data also shows that sintering and keying are the dominant anchorage mechanisms because they do not rely on friction between the fastener and the concrete.

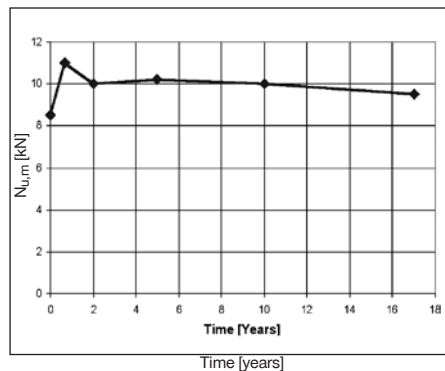

## 6.4 Effect on concrete components

Fastenings in the compression zone of the structure have no effect on concrete compressive resistance as long as detailed provisions on edge distance and spacing are complied with.

Fastenings in the tensile zone are subject to the following provisions:

- a. Installations on plain load-bearing components such as concrete walls or ceilings are generally possible without restrictions as the load-bearing behaviour of these components is only negligibly affected by the fasteners. The predominant condition is static loading. This statement is based on experimental investigations carried out at the Technical University of Braunschweig, Germany.
- b. Fastenings in reinforced concrete beams:

it has to be ensured that the main reinforcement steel will not be hit or penetrated by the DX fasteners. This measure of precaution is mainly founded on the reduction of the ultimate strain of the steel reinforcement. Exceptions are possible when the structural engineer responsible for design is consulted.

- c. Fastenings in pre-stressed concrete members:

it has to be ensured that the pre-stressing steel reinforcement or cables will not be hit or penetrated by the DX fasteners.

If the concrete is too thin, concrete will spall off on the rear surface. The minimum thickness of concrete depends on the shank diameter of the fastener used.

Fastener shank diameter $d_{nom}$ (mm)	Minimum concrete thickness $h_{min}$ (mm)
3.0	60
3.5 / 3.7	80
4.5	100
5.2	100

## 7. Masonry base material

### 7.1 General suitability

Direct fastening technology can also be used on masonry. The joints between bricks or blocks and the covering plaster layer on virtually all types of masonry (exception for

lightweight aerated concrete blocks) provide an excellent substrate for light-duty and secondary fastenings.

**Suitability table: DX fastening on masonry**

Masonry material	Unplastered masonry Fastenings in mortar joints* (joint width ≥ 10 mm)	Fastenings in masonry blocks or bricks	Plastered masonry Fastening in plaster (thickness ≥ 20 mm)
<b>Clay brick</b>			
solid	++	+	++
vertical perforated	++	---	++
horizontally perforated	++	---	++
<b>Clay clinker</b>			
solid	++	+	++
vertical perforated	++	---	++
<b>Sand-lime block</b>			
solid	++	++	++
perforated	++	++	++
hollow	++	++	++
<b>Aerated concrete</b>	---	---	---
<b>Lightweight concrete</b>			
solid	++	-	++
hollow	++	-	++
<b>Hollow concrete</b>	++	+	++
<b>Slag aggregate</b>			
solid	++	-	-
perforated	++	-	++
hollow	++	-	++
++ suitable	+ limited suitability	- not fully investigated	--- not suitable

\*) Joints must be completely filled with mortar

The above table is based on laboratory and field experience. Because of the wide variety of types and forms of masonry in use worldwide, users are advised to carry out tests on site or on masonry of the type and form on which the fastenings are to be made.

## 8. Temperature effects on the fastening

### 8.1 Effect of low temperatures on fasteners

Steel tends to become more brittle with decreasing temperature. Increased development of natural resources in Arctic regions has led to the introduction of steels that are less susceptible to brittle failure at subzero temperatures. Most siding and decking fasteners are used to fasten the liner sheets of an insulated structure and are not exposed to extremely low

temperatures during service. Examples of situations where the fastenings are exposed to extremely low temperatures during their service life are:

- Fastenings securing cladding in single-skin construction
- Construction sites left unfinished over a winter
- Liner sheets in a cold-storage warehouse

#### Low temperature embrittlement

The susceptibility of fasteners to become brittle at low temperatures can be shown by conducting impact bending tests over a chosen temperature range. The ability

of Hilti drive pins to remain ductile over a temperature range from +20°C to -60°C is shown clearly by the fact that the impact energy required remains nearly constant throughout this temperature range.

#### Impact bending test - DSH57 (4.5 mm diameter, HRC 58 ± 1)

Temperature		Impact energy (foot-pounds)			Impact energy (Joules)		
°F	°C	minimum	maximum	mean	minimum	maximum	mean
68	20	35.1	>36.1	>36.1	47.6	>48.9	>48.9
32	0	35.8	>36.1	36.0	48.5	>48.9	48.8
- 4	-20	31.4	>36.1	34.3	42.6	>48.9	46.5
-40	-40	34.4	36.5	35.7	46.6	49.4	48.4
-76	-60	35.6	36.2	35.9	48.2	49.0	48.7

#### Impact bending test - X-CR (4.0 mm diameter)

Temperature		Impact energy (foot-pounds)			Impact energy (Joules)		
°F	°C	minimum	maximum	mean	minimum	maximum	mean
68	20	14.8	17.0	15.9	20	23	21.6
32	0	17.7	15.5	18.3	24	21	24.8
- 4	-20	14.8	15.9	15.5	20	21.6	21.0
-40	-40	16.2	17.9	16.8	21.9	24.2	22.8
-76	-60	14.2	15.6	15.1	19.2	21.1	20.5

**Impact bending test - X-CR (3.7 mm diameter)**

Temperature		Impact energy (foot-pounds)			Impact energy (Joules)		
°F	°C	minimum	maximum	mean	minimum	maximum	mean
68	20	11.5	14.8	13.2	15.6	20.0	17.9
32	0	12.9	16.3	15.1	17.5	22.1	20.4
- 4	-20	13.1	15.8	14.7	17.8	21.4	19.9
-40	-40	14.2	15.8	14.8	19.2	21.4	20.1
-76	-60	12.3	15.0	13.7	16.7	20.3	18.6

Tests conducted according to DIN EN 10045 parts 1-4

Distance between supports = 22 mm

The symbol ">" indicates no breakage of the specimens. In the other cases, about 50% of the specimens suffered breakage.

**8.2 Effect of low temperatures on fastenings to steel**
**Effect of low temperatures on pull-out strength**

Tests show that very low temperatures tend to increase pull-out strength with both standard zinc-plated fasteners and with the stainless steel. The results of two tests are summarized below. The fasteners were

driven at room temperature and tested at  $-40^{\circ}\text{C}$  to  $-70^{\circ}\text{C}$ . A control sample was tested at  $20^{\circ}\text{C}$ . Explanations for the greater strength at low temperatures include increase in the strength of the zinc that is displaced into the knurling as well as increased strength of the fusing at the point of the fastener.

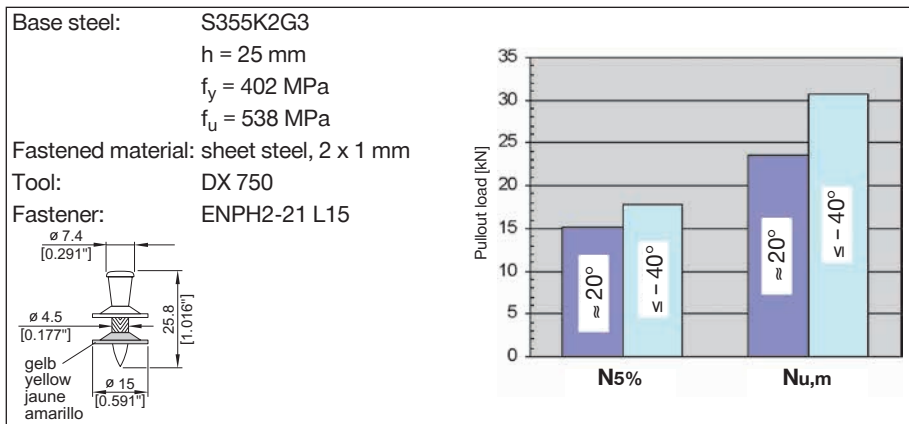

Base steel :  $h = 20 \text{ mm}$   
 $f_u = 450 \text{ MPa}$   
 Fastened material : none  
 Tool : DX 750 G  
 Fastener : X-CRM8-15-12 FP10

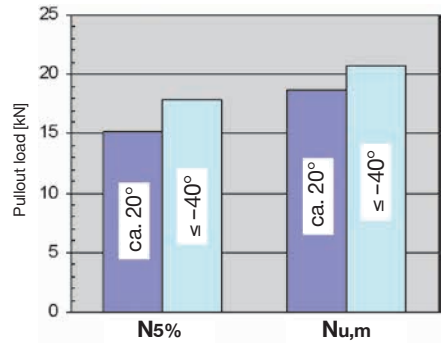
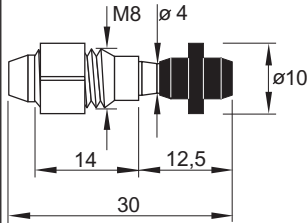

Two facts stand out from this testing:

- Pull-out strength increased as temperature decreased
- Pull-out from the base steel was the only mode of failure observed. There were no fractures!

### 8.3 Fire rating of fastenings to steel

#### Standard zinc-plated, thermally hardened steel fasteners

When subjected to high temperatures as in a fire, both powder-actuated fasteners

and structural steel lose strength. Data for standard zinc-plated, thermally hardened fasteners and structural steel are plotted in the graph below.

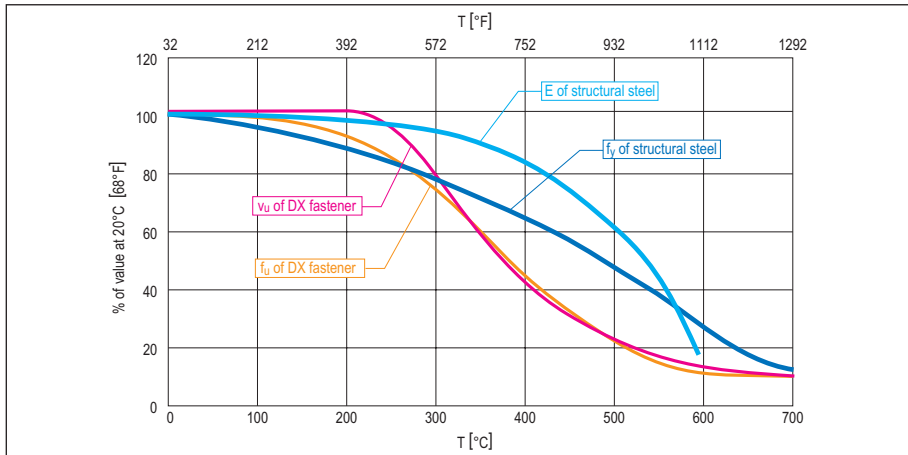

Up to about 300°C [572°F], the strength loss for DX fasteners is roughly proportional to the yield strength loss of structural steel. At 600°C [1112°F], DX fasteners have about 12% of their 20°C [68°F] strength left and structural steel about 26%. Since DX fasteners obtain their high strength through a thermal hardening process, the loss in strength at elevated temperatures is proportionally greater than for structural steel.

The relevance of different strength losses has to be evaluated in the context of the proportion of the material strengths that are actually exploited in a design. In a design calculation, it is conceivable that some steel will actually reach yield stress.

The material strengths of an X-ENP-19 L15 fastener is 30 kN [6.74 kips] in tension and 18.6 kN [4.18 kips] in shear respectively. The recommended working load in tension and shear for an X-ENP-19 L15 16 gauge (1.5 mm) fastening is 4.7 kN [1.057 kips] in tension and 4.6 kN [1.034 kips] in shear, respectively. Thus, the exploitation of the X-ENP-19 L15 strength at room temperature is only 16 to 25% compared to about 70% (at recommended stress level) for structural steel.

In a fire, powder-actuated fastenings will not be the governing factor. If the fire protection requirements permit the use of structural steel, then powder-actuated fastening can also be used without negative impact on fire protection.



CR500 stainless steel fasteners Hilti X-CR/X-CRM fasteners are much more resistant to loss of strength at high temperatures than standard fasteners. The effect of temperature on ultimate shear stress of stainless fasteners made of CR500 was determined in single lap joint shear

tests by the Swiss Federal Laboratory for Materials Testing and Research (EMPA). The results are plotted in the diagram below. This test was done by shearing 4.5 mm diameter fasteners that were inserted in steel plates with 4.6 mm diameter drilled holes.

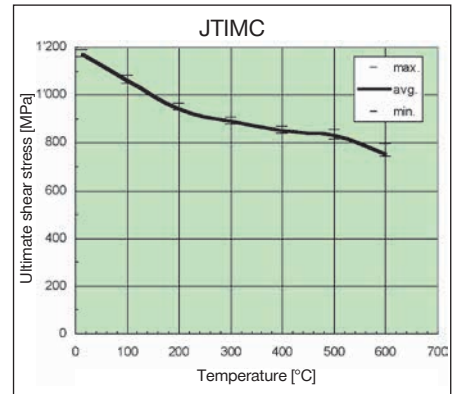
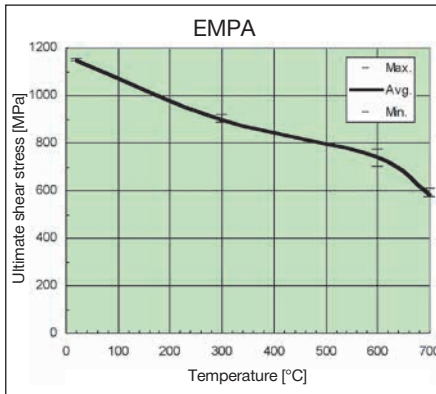

In Japan, similar tests were carried out by JTICM (Japan). These tests were done by driving a 4.5 mm diameter X-CR nail through a 6 mm steel plate into a second 6 mm thick steel plate and shearing the two plates. From the graph it is apparent that the results are nearly the same.

At 600°C, the CR500 material has 64% of its 20°C shear strength left. By comparison, standard fasteners have only 12% and structural steel only about 26%. The excellent fire resistance of the CR500 material alone justifies its use for some applications.

### 8.4 Fire rating of fastenings to concrete

Concrete is weakened and damaged by fire but not as quickly as steel. In ISO-standard fire tests conducted with DX-Kwik fastenings at the Braunschweig Technical University in Germany the only failure mode was fracture of the nails.

The actual test data are shown in the table below:

X-DKH 48 P8S15 DX-Kwik fastener, 4.0 shank

Tested in crack width $\Delta W$ (mm)	Tensile load, F (N)	Fire resistance/ time to failure (minutes)	Failure mode
0.2	250	103	Nail fracture
0.2	250	107	Nail fracture
0.2	350	73	Nail fracture
0.2	350	91	Nail fracture
0.2	500	56	Washer pullover
0.2	500	92	Nail fracture
0.2	500	93	Nail fracture

The stress in the fasteners at failure was calculated and plotted so that a plot of stress versus time resulted.

The characteristic failure stress curve from the previous graph can be used to calculate the failure load for various shank diameters with exposure to fire of different lengths of time. The calculated failure loads for 3.7, 4.0 and 4.5 mm shank diameter fasteners after 60, 90 and 120 minutes exposure to fire are shown in the table below.

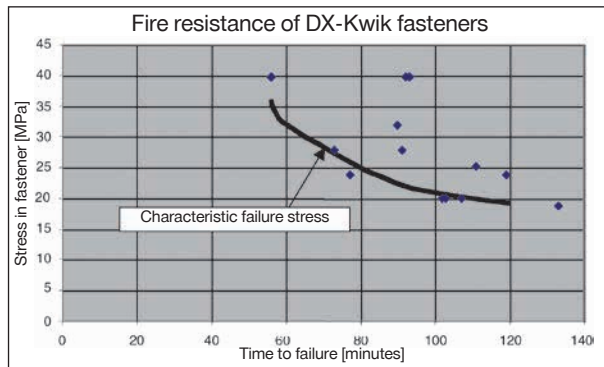

---

**Failure loads for various shank diameters and fire exposure times**

Shank diameter (mm)	Fire exposure time and failure stress		
	60 minutes	90 minutes	120 minutes
	32.1 MPa	22.3 MPa	19.1 MPa
3.7	340 N	240 N	200 N
4.0	400 N	280 N	240 N
4.5	510 N	350 N	300 N

This table can be used to determine recommended loads for the ISO fire resistance required.

## 9. Design concepts

The recommended working loads  $N_{\text{rec}}$  and  $V_{\text{rec}}$  are suitable for use in typical working load designs. If a partial factor of safety design method is to be used, the  $N_{\text{rec}}$  and  $V_{\text{rec}}$  values are conservative when used as  $N_{\text{Rd}}$  and  $V_{\text{Rd}}$ . Alternatively, the design resistance may be calculated from the recommended loads by multiplying by the factor 1.4, which considers the uncertainties from the load on the fasteners. Exact values

for  $N_{\text{Rd}}$  and  $V_{\text{Rd}}$  can be determined by using the safety factors where given and or reviewing test data. Based on cyclic tests it can be stated that DX fastenings can be said to be robust, even when the actual loading turns out to be in part cyclic. Design loads (characteristic strength, design resistance and working loads) for the **X-HVB** shear connector are listed and specified per design guideline.

The designer may encounter two main fastening design concepts:

Working load concept

$$N_S \leq N_{\text{rec}} = \frac{N_{\text{Rk}}}{\gamma_{\text{GLOB}}}$$

where  $\gamma_{\text{GLOB}}$  is an overall factor of safety including allowance for:

- errors in estimation of load
- deviations in material and workmanship

and  $N_S$  is in general a characteristic acting load.

$$N_S \approx N_{\text{Sk}}$$

Partial factors of safety

$$N_{\text{Sk}} \cdot \gamma_{\text{F}} = N_{\text{Sd}} \leq \frac{N_{\text{Rk}}}{\gamma_{\text{M}}} = N_{\text{Rd}}$$

where:

$\gamma_{\text{F}}$  is a partial factor of safety to allow for errors in estimation on the acting load and

$\gamma_{\text{M}}$  is a partial factor of safety to allow for deviations in material and workmanship.

The characteristic strength is defined as 5 % fractile:

$$N_{Rk} = N_{u,m} - k \cdot s$$

The k factor is a function of the sample size and the accuracy required. The characteristic strength of fastenings to concrete is determined based on a 90% probability while fastenings to steel are based on a 75% probability.

Structural analysis of the fastened part (e.g. roof deck panel or pipe hung from a number of fastenings) leads to calculation of the load acting on a single fastening, which is then compared to the recommended load

(or design value of the resistance) for the fastener. In spite of this single-point design concept, it is necessary to ensure adequate redundancy so that failure of a single fastening will not lead to collapse of the entire system. The old saying “one bolt is no bolt” can also be applied to DX fastening.

For standard DX fastenings on concrete, a probability-based design concept based on multiple fastening is applied in order to allow for fastener driving failures and the large scatter in holding power observed. This concept applies to tensile as well as shear loading and is described in following chapter.

## 10. Determination of technical data for fastening design

The determination of technical data is based on the following tests:

- Application limits
- Tensile tests to determine pull-out and pull-over strength
- Shear tests to determine bearing capacity of the attached material and the base material.

These tests are described in more detail in the sections “Steel and other metal base material” and “Concrete base material”.

### 10.1 Fastenings to steel

Failure loads in tension and in shear are normally distributed and the variation coefficient is  $< 20\%$ . The test data for each test condition are evaluated for the average and characteristic values. The characteristic value is based on the 5% fractile for a 75% probability.

The application range of the fastener is determined by application limit test where fasteners are set on steel plates of thickness ranging from the minimum recommended thickness  $t_{l,min}$  to full steel ( $\geq 20$  mm) and varied plate strength.

The application limit is reached when 1 shear off failure with 30 fasteners tested occurs, or if a detrimental effect on the load values (resistance) occurs.

Due to the small scatter in failure loads fastenings in steel can thus be designed as single points, although good engineering practice should be kept in mind. System redundancy must be always ensured.

## 10.2 Profile sheet fastenings

In addition to general fastenings to steel, specific data applies to profile sheet fastenings:

### Cyclic loading

Profile sheet fastenings are subjected to repeated loading to simulate wind effects. Cyclic pull-through tests are additional optional tests where the failure load at 5,000 cycles is determined.

The design value of the pull-through resistance for repeated wind loads is the design value of the static pull-through resistance multiplied by a reduction factor of  $\alpha_{cycl}$ .

- If cyclic tests are carried out:

$$\alpha_{cycl} = 1.5 (N_{Rk,cycl} / N_{Rk,sta}) \leq 1$$

(The factor 1.5 takes the different safety levels for fatigue and predominately static design into account)

- If no cyclic tests are carried out:

$$\alpha_{cycl} = 0.5$$

### Sheet bearing capacity

Profile sheet fastenings may be subjected to shear stresses from building movements or thermal dilatation of the sheets. Tests are undertaken to prove the suitability of the fastenings to support the deformations imposed.

For this, shear tests are carried out using a substrate of the minimum and maximum thickness and 2 layers of profile sheet of the thickness specified.

The fastening is considered suitable if an elongation of 2 mm is achieved without the sheet coming loose or showing an excessive reduction in pull-out load capacity. In this case, no consideration of forces of constraint is required since sufficient ductility is provided by the fastening due to hole elongation.

### Standardization

The pull-over strength of profiled sheet fastenings is given with reference to core sheet thickness. Ultimate load data is standardized to the minimum sheet thickness and strength as specified by the relevant sheet standard. The correction applied is as follows:

$$F_{U'} = F_U \cdot \frac{t_{min}}{t_{act}} \cdot \frac{f_{u,min}}{f_{u,act}}$$

### 10.3 Fastenings to concrete (standard DX / GX / BX)

The failure loads in tension and shear show a large scatter with a variation coefficient of up to 60%. For specific applications, fastener driving failures may be detected and the fasteners replaced (e.g. threaded studs). For others, however, detection may not be possible (e.g. when fastening wooden battens) and this must be taken into consideration.

The design resistance is therefore determined for:

- failure loads without considering fastener driving failures
- failure loads considering a 20% rate of fastener driving failure

Evaluation of technical data and design according to the single point design approach based on fractiles and a safety factor is not feasible for such systems. The characteristic value would become zero at a variation coefficient of about 50%.

The evaluation of the data and the determination of the design resistance is therefore based on a multiple fastening, i.e. a redundant design, in which the failure probability not of a single, but of a number of fasteners supporting a structure is calculated. By this system, load may be transferred between the fasteners, if slip or failure of one or more of the fasteners occurs.

#### Test data

The test data for the fastener is consolidated to form a master pullout load distribution.

#### Static system

Two static systems are examined

- A suspended beam allowing unrestrained flexure of the beam
- A beam directly attached to the surface, which shows restrained flexure

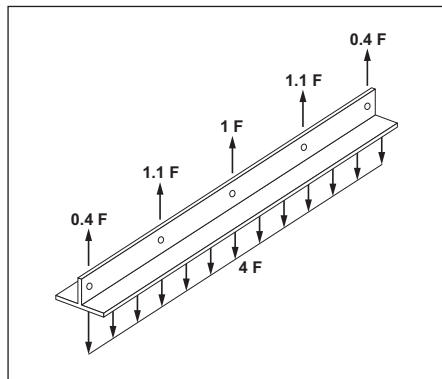



### Calculation method

The calculation method used is the Monte Carlo method, by which holding values taken stochastically from the master distribution are attributed to the individual fasteners of the system and the system is checked to determine whether the imposed line load can be supported. By performing a large number of such simulations, statistical information on the failure probability of a system under a given line load is obtained. Hidden setting failures can also be considered with this method.

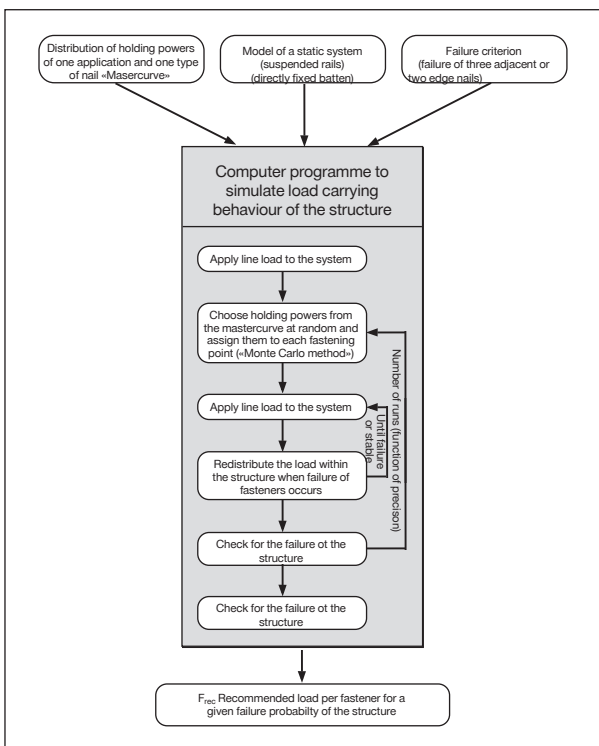

### Design parameters

The design is based on the following parameters:

- Failure probability:  $1 \cdot 10^{-6}$
- Number of fasteners: 5
- Line load uniformly distributed
- Failure criterion: 2 edge or 3 central fastenings

The result is expressed in recommended load per fastening.

### Effect on a fastening design

The overall condition for a fastening design in practice is that redundancy of the complete system has to be ensured. The effect of the Monte Carlo approach on a design is illustrated with two examples below.

#### Example:

Fastening of a plumbing with five ceiling hangers.

1. Due to the stiffness (EI) of the plumbing a redistribution of the dead load (g) to the remaining hangers is given in case of two neighbouring hangers failing.

( Fixing of each hanger with one nail is sufficient.

2. The plumbing is not stiff enough to redistribute the dead load to the neighbouring hangers in case of one fastener failing.

( Each hanger has to be fastened with five nails.

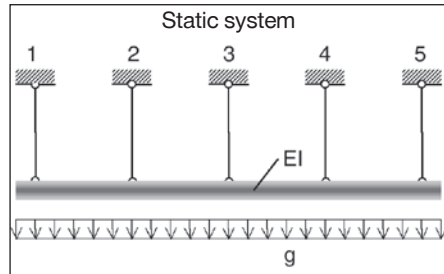

### 10.4 DX fastenings to concrete (DX-Kwik)

Failure loads in tension and shear are log-normally distributed and the variation coefficient is <20 %. The test data is evaluated to yield the 5 % fractile based on a 90% probability. The recommended working loads are obtained by applying a global safety factor of 3 for tension and shear.

The determination of technical data for cracked concrete (tensile zone) is based on tensile tests. Shear tests in cracked and uncracked concrete give similar results and are therefore not performed.

Failure loads in cracked concrete show a higher variation coefficient. Test data is also evaluated to yield the 5% fractile. The recommended load for the tensile zone is taken as the smaller of the following values:

- $N_{rec} = N_{RK} / \gamma_{GLOB}$       $\gamma_{GLOB} = 3.0$  for 0.2 mm crack width
- $N_{rec} = N_{RK} / \gamma_{GLOB}$       $\gamma_{GLOB} = 1.5$  for 0.4 mm crack width.

The application range of the fastener is determined by application limit test where fastenings are made on concrete of varying strength and age according to the application conditions specified (pre-drilling and setting). The attachment height is kept at the lower end of the range specified. The application limit is reached, if the failure rate exceeds 3% or the pull-out values strongly deviate from a lognormal distribution. The sample size is 30 per condition.

### 10.5 Fastener design in the USA and Canada

Testing of powder-actuated fasteners is carried out according to the ICC-ES AC 70 acceptance criteria and ASTM E 1190 standard test method. The test procedure covers tensile and shear testing in steel, concrete and masonry.

The determination of the allowable (recommended) load is shown below. The recommended working load is derived from the test data by taking the average failure load or the calculated characteristic load divided by a global safety factor.

$$P_a = V_a = F_{all} = \frac{F \cdot R \cdot R_f}{\Omega} \quad (3-1)$$

where:

- $F$  = Average ultimate load [lbf (N)] of the test series.
- $\Omega$  = Safety factor determined in accordance with Section 3.3.2.
- $R$  = Most severe base material reduction factor determined in accordance with Section 3.3.3.1, 3.3.3.2, or 3.3.3.3, as applicable.
- $R_f$  = Fastener based reduction factor, determined in accordance with Section 3.3.3.4, as applicable.

**Exception:** When testing satisfies the alternate sample size described in Section 8.1 of ASTM E1190 (the COV from ten tests is 15 percent or greater),  $F$  shall be taken as the lowest ultimate load of the ten tests and  $\Omega$  shall be taken as 5.

**3.3.2 Safety Factor,  $\Omega$ :** The safety factor shall be determined using Equation 3-2.

$$\Omega = \frac{3.5}{(1 - 2COV)} \geq 5 \quad (3-2)$$



Part 2:

## Fastener selection guide

## 1. Selecting the right fastener

These considerations are used to determine suitable powder-actuated (DX), gas-actuated (GX) or battery-actuated (BX) fasteners for a given application.



Detailed technical information for the selected fastener family can be found on its product data sheet on the displayed pages.

For some applications, two or more fastener families are listed as suitable. The final selection is influenced by specific application requirements, available tools and technical data can be found on the product sheets.

Regional differences in building methods, materials, trade preferences, available tools, etc. also influence fastener selection. Therefore, designers and specifiers are advised to consult the local Hilti website and make use of the local Hilti technical advisory service.

## 1.1 Selection based on the type of concrete

### What determines nail performance

Hilti Direct Fastening systems are designed to achieve maximum performance in a wide range of applications. But there is a large variety of nails types and elements for various direct fastening concrete applications. To select the appropriate nail for a given application, some important influencing parameters need to be considered:

- a) concrete properties,
- b) nail design and features
- c) fastening system used
- d) nail embedment depth
- e) fastening tools and energy level

#### a) Concrete properties

A nail penetrating concrete needs to create a hole for the shank by crushing and compacting the concrete and also needs to withstand hitting hard aggregates. The resulting holding value achieved by the nail is linked to its diameter and embedment depth.

High penetrability and compactability lead to high stick rates and holding values.

Note: Concrete compressive strength alone is not decisive for nail performance.

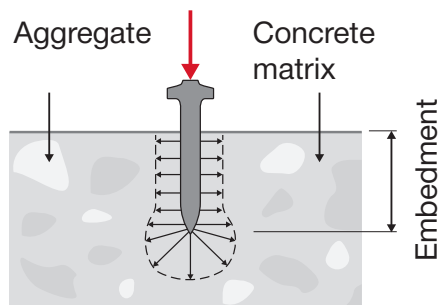

Four concrete types can be roughly distinguished:

<div style="background-color: #d3d3d3; border-radius: 50%; width: 40px; height: 40px; display: flex; align-items: center; justify-content: center; margin: 0 auto;">S</div> <p>Soft</p>	<ul style="list-style-type: none"> <li>• Low to medium compressive strength, <math>f_{c, \text{cube}} \approx 10+35</math> MPa</li> <li>• Soft and small size aggregates</li> <li>• Concrete age earlier than 28 days</li> </ul> <p>Example:</p> <ul style="list-style-type: none"> <li>• Lightweight concrete, young concrete</li> <li>• Compressive strength class C12/15 acc. to EN 206</li> </ul>
<div style="background-color: #d3d3d3; border-radius: 50%; width: 40px; height: 40px; display: flex; align-items: center; justify-content: center; margin: 0 auto;">M</div> <p>Medium</p>	<ul style="list-style-type: none"> <li>• Medium compressive strength, <math>f_{c, \text{cube}} \approx 25+45</math> MPa</li> <li>• Average hard and small to medium size aggregates</li> </ul> <p>Example:</p> <ul style="list-style-type: none"> <li>• Normal weight concrete for interior floor slabs</li> <li>• Compressive strength class C20/25 acc. to EN 206</li> </ul>
<div style="background-color: #d3d3d3; border-radius: 50%; width: 40px; height: 40px; display: flex; align-items: center; justify-content: center; margin: 0 auto;">T</div> <p>Tough</p>	<ul style="list-style-type: none"> <li>• Medium to high compressive strength, <math>f_{c, \text{cube}} \approx 45+65</math> MPa</li> <li>• Average hard and medium size aggregates, e.g. limestone, pit gravel, some granite</li> </ul> <p>Example:</p> <ul style="list-style-type: none"> <li>• Normal weight concrete in historic buildings</li> <li>• Compressive strength class C50/60 acc. to EN 206</li> </ul>
<div style="background-color: #d3d3d3; border-radius: 50%; width: 40px; height: 40px; display: flex; align-items: center; justify-content: center; margin: 0 auto;">V</div> <p>Very tough</p>	<ul style="list-style-type: none"> <li>• High compressive strength, <math>f_{c, \text{cube}} &gt; 65</math> MPa</li> <li>• Hard and medium size aggregates, e.g. quartz, basalt, greywacke</li> </ul> <p>Example:</p> <ul style="list-style-type: none"> <li>• Ultra-high-performance concrete</li> <li>• Compressive strength class C70/80 acc. to EN 206</li> </ul>

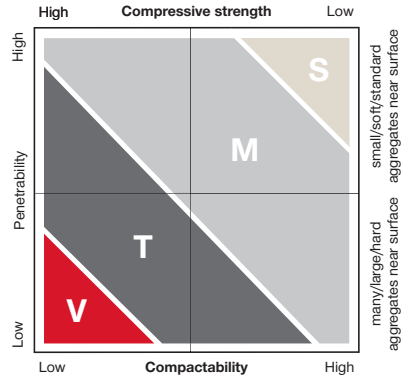

Note:  $f_{c, \text{cube}}$  = compressive strength of concrete cube (150 mm edge length)

### b) Nail design and features

Penetrability and compactability, i.e. a nail's ability to penetrate and compact the concrete, are strongly influenced by three nail design features:

#### Point type

The point type and the reduction of the diameter in the area of the tip allows a significantly improved penetration behaviour in concrete.



#### Nail geometry

Length and diameter also affect how easily the nail penetrates the concrete.

#### Nail hardness

A harder nail is easier to drive into tougher concrete. However, if the nail is too hard, it can break instead of bending when it hits a hard aggregate in the concrete.

### c) Fastening systems used

Hilti Direct Fastening Systems help to ensure that nails are correctly driven by achieving maximum nail perpendicularity, good nail guidance and thorough use of the appropriate driving energy.

#### Perpendicularity

Hilti Direct Fastening tools help to keep nails perpendicular to the working surface, thus reducing failures caused by nails driven at an angle. During the fastening process, Hilti Direct Fastening tools have to be maintained perpendicular to base material as much as possible. Please refer to the respective instructions for use and tool operation manuals for details.

#### Nail guidance

Due to excellent nail guidance in the tool and the use of solid washers, the nail leaves the tool at the intended angle.

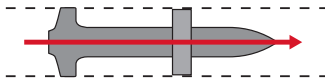

### d) Nail embedment depth

Another factor that influences nail performance is embedment depth. A nail that can be driven deeper in the concrete has the ability to achieve higher load performance. However, there are two side effects if a nail needs to be driven deeper.

- stick rate can decrease
- higher driving energy is required as the nail must penetrate further into the concrete

### e) Fastening tools and energy levels

Nail driving energy released by a Hilti tool is precisely controlled to help achieve the desired embedment depth reliably.

#### Powder-actuated tools (DX)

Embedment depth of a nail can be influenced by selecting the right cartridge color and adjusting the power setting on the tool, where applicable.

Hence, it is crucial to understand how the different tools in combination with the various cartridges, vary in terms of energy generation. Use that knowledge to pick the right tool and the right cartridge to help achieve the required embedment depth and reach the optimum nail load performance.

#### Gas-actuated tools (GX)

Embedment depth can be influenced by adjusting the slider in the front of the tool to “+” or “-” position.

#### Battery-actuated tools (BX)

Embedment depth can be influenced by selecting a different nail length.



### Choice of a nail for use on concrete

Three main factors define the nail selection on concrete:

- speed of installation
- stick rate
- holding values

#### Speed of installation

All system technologies, powder-actuated tool (DX), gas-actuated tool (GX) and battery-actuated tool (BX) offer a very high installation speed.

#### Stick rate

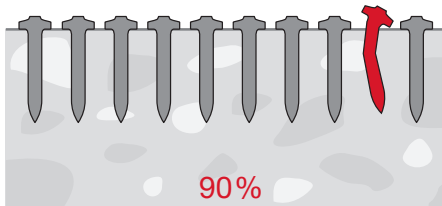

The stick rate indicates the percentage of nails that are driven correctly to carry a load.

Generally, stick rate can often be improved by combination of:

- using shorter nails  
(on condition that required load can still be achieved with shorter embedment)
- selecting nails from a higher nail class  
(nail classes are described later in this chapter)
- using more energy by combination of tools, cartridges and energy setting
- using different technologies and nails from a higher nail class, i.e. switching from gas-actuated (GX) or battery-actuated tools (BX) to powder-actuated tools (DX)
- pre-drilling, see chapter Kwik

#### Holding values

Holding values provide a measure of a nail's load-bearing capacity which ensures the reliable use in practical applications, consistent with their diameter and embedment depth. Nails are typically subject to static or quasi-static loads, which act as tensile, shear or combined tensile and shear forces.

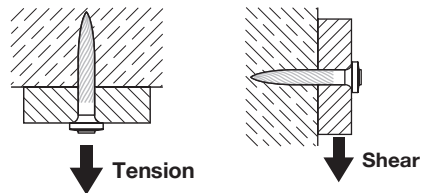

## Nail types

Different nails have been developed for various applications and conditions.

Medium duty Class I and II nails are used for load-sensitive high performance applications in tough concrete, while medium duty Class III nails are for versatile use in soft, medium and tough concrete. Medium duty Class I, II and III nails are generally fastened with powder-actuated tools (DX).

Light duty Class IV and V nails, generally fastened with gas-actuated (GX) and battery actuated tools (BX), are typically used for applications that have lower load requirements, hence requiring shorter embedment depth. In general, Class V nails present the most economical solution as they are the least costly.

Cost is directly related to the manufacturing technologies involved as well as the material from which the nails are made.

Under harsher conditions, each nail class performs better than the one below, and the manufacturing costs, and thus the price of the nail, increase with each nail class.

	Nail Class	Nail featured			Concrete Class	Nail examples	Applications
		Ø	Hardness [HRC]	Tip			
Medium duty	Class I	> 4.0 mm	> 58	Helical long conical		X-X X-AL-H <sup>1)</sup>	Best performance in tough concrete.
	Class II	4.0 mm	Up to 60	Ballistic better		X-P X-U	High performance in tough concrete.
	Class III	3.5 to 3.7 mm	Up to 58	Mostly cut		X-C	High performance in medium concrete.
Light duty	Class IV	3.0 to 3.2 mm	Up to 58	Ballistic better		X-P G2/G3/B3	Use in soft, medium and some tough concrete with shorter embedment, e.g. for track fastening to slab underside.
	Class V	2.6 to 3.0 mm	Up to 57	Mostly cut		X-C G2/G3/B3	Use in soft and medium concrete with shorter embedment, e.g. for track fastening.

<sup>1)</sup> X-AL-H nail is pre-mounted to X-CX ceiling fasteners

Nail class versus concrete type

Stick rate versus holding values of nail classes

Nail classes are clearly differentiated when faced with tough concrete. Depth of embedment, nail geometry, hardness and tip shape vary between nail classes.

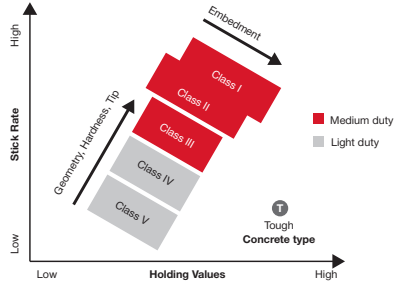

Stick rate of nail classes in different concrete types

Nail performance varies depending on the toughness of the concrete and the distribution of its aggregates. Nails of all classes perform similarly in soft concrete, but as the concrete gets tougher, the stick rate varies.

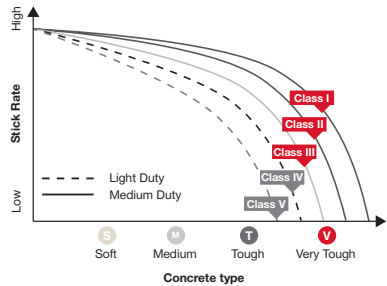

## Select the right nail for concrete

Here are four simple steps to help guide you to the right nail

1. Understand the application
2. Be specific about important application requirements
3. Get to know the Hilti range of nails
4. Then choose the right nail based on application requirements



Following these four steps will help you:

- Maximize the stick rate.
- Achieve the required holding values.
- Select the most cost-efficient nail.
- Achieve optimum embedment depth based on selecting the appropriate cartridge and adjusting the power setting.



Improving the stick rate can be done in three different ways:

1. Use a shorter nail (if required embedment / load still can be reached with shorter nail)
2. Select a nail from a higher nail class (move from Nail Class III to II)
3. Use more energy (energy setting) / select different technology

Example:

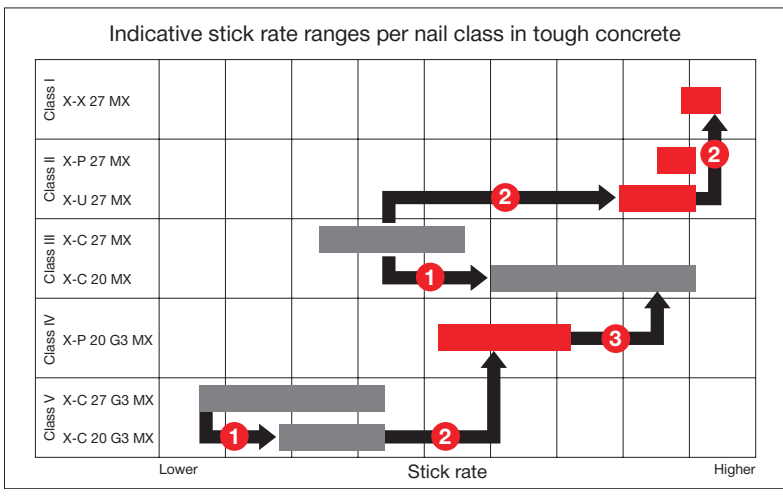

- no power and cartridge selection required for GX and BX systems.
- Important: other application relevant requirements, e.g. environmental conditions, corrosion resistance, etc., must be considered.

## 1.2 Selection based on environmental conditions

Corrosion may have a major influence on the suitability of a fastener for an application and therefore also on fastener selection. In order to provide a basis for judging the suitability of fasteners, it is useful to categorise applications in three classes:

- Non-safety relevant, temporary fastenings (e.g. fastenings of wooden kickers in concrete formwork)
- Non-safety relevant, permanent fastenings (e.g. metal track fastenings for drywall)
- Safety relevant, permanent fastenings (e.g. profiled metal sheet fastenings in roof and walls)

**Non-safety-relevant , temporary and permanent fastenings:** zinc-plated fasteners made of normal carbon steel can be used without restriction. Corrosion and related damages can, however, reduce the capacity of fasteners.

**Safety-relevant, permanent fastenings:** the restrictions described below apply:

- In any case where there is a restriction to use galvanized carbon steel fasteners if they are exposed to weather or if they are inside and subject to repeated wetting as from condensation. The galvanization (typically in a range from 5 to 20 microns of Zn) provides corrosion protection during transport and construction, during which exposure to weather can never be completely prevented. If the fastenings are exposed to repeated wetting or weather during their service life, the use of galvanized carbon steel fasteners is prohibited and stainless steel fasteners must be used. This safety measure must be observed without exception because the corrosion of galvanized steel fasteners leads not just to material loss but also to hydrogen embrittlement. Hydrogen embrittlement can easily result in fracture of the fastener at very low load.
- Referring to the above-mentioned example of profiled metal sheet fastening for roofs and walls, the use of galvanized steel fasteners is allowable only where wetting of the fastener is not to be expected. This applies in general to inside skins of two skin, insulated roofs and walls enclosing dry and closed rooms. This is the classic application area for X-ENP 19 galvanized fasteners.
- For special applications like swimming pools or tunnels, highly corrosion-resistant resistant stainless steel materials are recommended. See also Part 4, Chapter 4. Please consult Hilti in such cases

**Contact corrosion** is taken into consideration by observing common rules concerning acceptable material combinations. Parts made of less noble metals are subject to increased corrosion if they are in electrochemical contact with a larger part made of a more noble metal, provided of course that an electrolyte is present. Fasteners that are used in wet areas must be at least as noble or better nobler than the fastened part. The effect of contact corrosion is shown in the table below. This information is especially applicable to stainless steel fasteners, like X-CR, X-ST-GR and X-R, because these are suitable for safety-relevant, permanent application in outdoor areas or areas otherwise exposed to corrosion.

Fastened material	Power-actuated fastener	
	Zinc-plated carbon steel	Stainless steel
Construction steel (uncoated)	s	s
Galvanized steel sheet	s	s
Aluminum alloy	d	s
Stainless steel sheet	d	s

s = Negligible or no corrosion of fastener, d = Heavy corrosion of fastener

Accelerated corrosion of a fastener due to contact corrosion can take place only in the presence of an electrolyte (moisture from precipitation or condensation). Without this electrolyte – e.g. in dry inside rooms – zinc-plated fasteners can be used in connection with more noble metals.

## 2. Design concepts

The recommended working loads ( $N_{rec}$  and  $V_{rec}$ ) are suitable for use in typical working load designs. If a partial safety factor design method is to be used, the  $N_{rec}$  and  $V_{rec}$  values are conservative when used as  $N_{Rd}$  and  $V_{Rd}$ . Exact values for  $N_{Rd}$  and  $V_{Rd}$  can be determined by using the safety factors where given and/or by reviewing test data. Design loads (characteristic strength, design resistance and working loads) for the X-HVB shear connector are listed as per design guideline.

Worldwide the designer may encounter two main fastening design concepts:

Working load concept

$$N_S \leq N_{rec} = \frac{N_{Rk}}{\gamma_{GLOB}}$$

where  $\gamma_{GLOB}$  is an overall factor of safety including allowance for:

- errors in estimation of load
- deviations in material and workmanship

and  $N_S$  is, in general a characteristic acting load.

$$N_S \approx N_{Sk}$$

Partial factors of safety

$$N_{Sk} \cdot \gamma_F = N_{Sd} \leq \frac{N_{Rk}}{\gamma_M} = N_{Rd}$$

where:

$\gamma_F$  is a partial factor of safety to allow for errors in estimation on the acting load.

$\gamma_M$  is a partial factor of safety to allow for deviations in material and workmanship.

Structural analysis of the fastened part (e.g. roof deck panel or pipe hung from a number of fastenings) leads to calculation of the load acting on a single fastening, which is then compared to the recommended load (or design value of the resistance) for the fastener. In spite of this single point design concept, it is necessary to ensure that there is sufficient redundancy that the failure of a single fastening will not lead to collapse of the entire system. The old saying “one bolt is no bolt” applies also to Direct fastening.

### 3. Nomenclature/symbols

Following is a table of symbols and nomenclature used in the technical data.

#### Fastener test data and performance

N and V	Tensile and shear forces in a general sense.	
F	Combined force (resulting from N and V) in a general sense.	
N <sub>s</sub> and V <sub>s</sub>	Tensile and shear forces acting on a fastening in a design calculation.	
F <sub>s</sub>	Combined force (resulting from N <sub>s</sub> and V <sub>s</sub> ) in a design calculation.	
N <sub>u</sub> and V <sub>u</sub>	Ultimate tensile and shear forces that cause failure of the fastening; statistically, the reading for one specimen.	
N <sub>u,m</sub> and V <sub>u,m</sub>	Average ultimate tensile and shear forces that cause failure of the fastening, statistically, the average for a sample of several specimens.	
S	The standard deviation of the sample.	
N <sub>test,k</sub> and V <sub>test,k</sub>	Characteristic tensile and shear resistance of test data, statistically, the 5 % fractile.	
N <sub>Rk</sub> and V <sub>Rk</sub>	<p>Characteristic tensile and shear resistance of the fastening used for fastening design; statistically, the 5 % fractile. For example, the characteristic strength of a fastening whose ultimate strength can be described by a standard Gauss type distribution is calculated by:</p> $N_{Rk} = N_{u,m} - k \cdot S \quad \text{where } k \text{ is a function of the sample size } n \text{ and the desired confidence interval.}$	
N <sub>Rd</sub> and V <sub>Rd</sub>	<p>Tensile and shear design resistance of the fastening</p> $N_{Rd} = \frac{N_{Rk}}{\gamma_M} \quad \text{and} \quad V_{Rd} = \frac{V_{Rk}}{\gamma_M} \quad \text{where } \gamma_M \text{ is a partial safety factor for the resistance of the fastening.}$	
N <sub>rec</sub> and V <sub>rec</sub>	<p>Recommended tensile and shear force of the fastening</p> $N_{rec} = \frac{N_{Rk}}{\gamma_{GLOB}} \quad \text{and} \quad V_{rec} = \frac{V_{Rk}}{\gamma_{GLOB}} \quad \text{where } \gamma_{GLOB} \text{ is an overall factor of safety.}$	
M <sub>rec</sub>	<p>Recommended working moment on the fastener shank</p> $M_{rec} = \frac{M_{Rk}}{\gamma_{GLOB}}$ <p>where M<sub>Rk</sub> is the characteristic moment resistance of the fastener shank and γ<sub>GLOB</sub> is an overall factor of safety. Unless otherwise stated on the product data sheets, the M<sub>rec</sub> values in this manual include a safety factor of "2" for static loading.</p>	



### Fastening details

$h_{ET}$	Penetration of the fastener point below the surface of the base material.
$h_{NVS}$	Nail head standoff above the surface fastened into (with nails, this is the surface of the fastened material, with threaded studs, the surface of the base material).
$t_{II}$	Thickness of the base material.
$t_I$	Thickness of the fastened material.
$\Sigma t_I$	Total thickness of the fastened material (where more than one layer is fastened).

### Characteristics of steel and other metals

$f_y$	Yield strength of steel.
$f_u$	Tensile strength of steel.

### Characteristics of concrete and masonry

$f_c$	Compressive strength of cylinder (150 mm diameter, 300 mm height).
$f_{cc}$	Compressive strength of cube (150 mm edge length).
$f_{c,100} / f_{c,200}$	Compressive strength of 100 mm diameter cylinder / cube with 200 mm edge length.

Approvals, technical assessments and design guidelines are given on the product information sheets as abbreviations of the names of the issuing institutes or agencies.



Following is a list of abbreviations:

Abbreviation	Name of institute or agency / description	Country
FM	Factory Mutual (insurers' technical service)	USA
UL	Underwriters Laboratories (insurers' technical service)	USA
ICC	International Code Council	USA
SDI	Steel Deck Institute (technical trade association)	USA
CSTB	Centre Scientifique et Technique du Bâtiment (approval agency)	France
DIBt	Deutsche Institut für Bautechnik (approval agency)	Germany
SOCOTEC	SOCOTEC (insurers' technical service)	France
ÖNORM	Österreichische Norm / Austrian National Standard	Austria
SCI	Steel Construction Institute	Great Britain
ABS	American Bureau of Shipping (international classification society for ship and marine structures).	
LR	Lloyd's Register (international classification society for ship and marine structures).	
DNV GL	International classification society for the marine and energy industry.	

## 4. Tips for users

## Tips for users (“Trouble Shooting”)

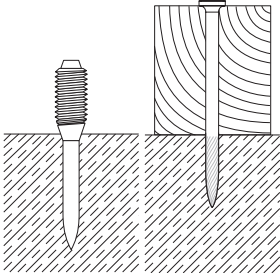
### DX fastenings on concrete

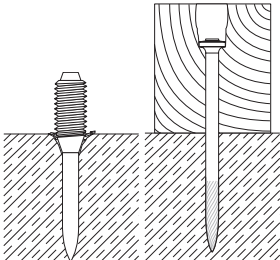
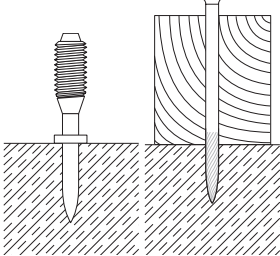
Observation	Cause	Possible remedial measures
<p><b>Fastener properly fixed</b></p> 	<ul style="list-style-type: none"> <li>• Proper*) length of fastener</li> <li>• Proper cartridge</li> <li>• Proper power setting</li> </ul>	
<p><b>Fastener penetrates too deep</b></p> 	<ul style="list-style-type: none"> <li>• Fastener too short*)</li> <li>• Too much driving power</li> </ul>	<ul style="list-style-type: none"> <li>• Use longer fastener</li> <li>• Reduce power setting</li> <li>• Use lighter cartridge</li> </ul>
<p><b>Fastener does not penetrate deep enough</b></p> 	<ul style="list-style-type: none"> <li>• Fastener too long*)</li> <li>• Too little driving power</li> </ul>	<ul style="list-style-type: none"> <li>• Use shorter fastener</li> <li>• Increase power setting</li> <li>• Use heavier cartridge</li> </ul>

\*) **Rule of thumb:** The higher the compressive strength of concrete, the shorter the fastener  
**Proper length (mm):**  $L_s = 22 + t_1$  (compare, “Fastening Technology Manual” Part Product section)

**DX fastenings on concrete**

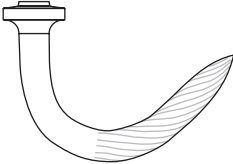
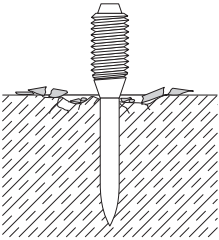
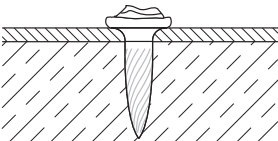
Observation	Cause	Possible remedial measures
<p><b>Nail is bending</b></p> 	<ul style="list-style-type: none"> <li>• Hard and/or large aggregate in concrete</li> <li>• Rebar close to surface of concrete</li> <li>• Hard surface (steel)</li> </ul>	<ul style="list-style-type: none"> <li>• Use shorter nail</li> <li>• Use DX-Kwik (predrill)</li> <li>• Use stepped shank nail X-U 15</li> <li>• Change cartridge</li> </ul>
<p><b>Base material is spalling</b></p> 	<ul style="list-style-type: none"> <li>• High strength concrete</li> <li>• Hard and/or large aggregate in concrete</li> <li>• Old concrete</li> </ul>	<ul style="list-style-type: none"> <li>• Stud application: Use spall stop X-460-F8SS / - F10SS</li> <li>• Nail application: Use shorter nail Use DX-Kwik (predrill) Use X-U 15 (for highstrength precast concrete)</li> </ul>
<p><b>Damaged nail head</b></p> 	<ul style="list-style-type: none"> <li>• Too much driving power</li> <li>• Wrong piston used</li> <li>• Damaged piston</li> </ul>	<ul style="list-style-type: none"> <li>• Reduce power setting</li> <li>• Use lighter cartridge</li> <li>• Check nail-piston-combination</li> <li>• Change piston</li> </ul>

**Wrong pistons can cause all the above faults: match pistons to nails!**

Fastener	Piston	Piston tip
X-U, X-C, X-P	Use piston X-460-P8	

**DX fastenings on steel**

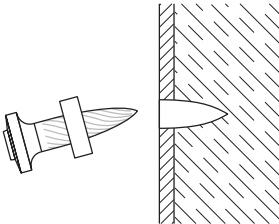
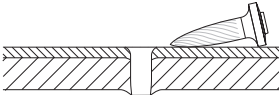
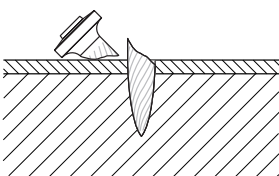
Observation	Cause	Possible remedial measures
<p><b>Nail does not penetrate surface</b></p> 	<ul style="list-style-type: none"> <li>• Too little driving power</li> <li>• Application limit exceeded (very hard surface)</li> <li>• Unsuitable system</li> </ul>	<ul style="list-style-type: none"> <li>• Try higher power setting or heavier cartridge</li> <li>• Short nail application: Try X-U 15</li> <li>• Long nail application: Try X-U</li> <li>• Use co-acting principle/ fastener guide</li> <li>• Switch to heavy system like DX 76 PTR</li> </ul>
<p><b>Nail does not hold in base material</b></p> 	<ul style="list-style-type: none"> <li>• Excess driving energy in thin steel base material (3 to 4 mm steel)</li> </ul>	<ul style="list-style-type: none"> <li>• Try different power setting or different cartridge</li> <li>• Try X-ENP2K or X-EDNK22 THQ 12 for fastening sheet metal</li> </ul>
<p><b>Nail is breaking</b></p> 	<ul style="list-style-type: none"> <li>• Too little driving power</li> <li>• Application limit exceeded (very hard surface)</li> </ul>	<ul style="list-style-type: none"> <li>• Try higher power setting or heavier cartridge</li> <li>• Use shorter nail</li> <li>• Use X-ENP19</li> <li>• Use stronger nail (X-...-H)</li> <li>• Use stepped shank nail: X-U 15</li> </ul>

## DX fastenings on steel

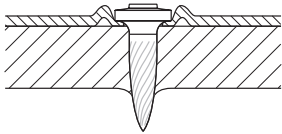
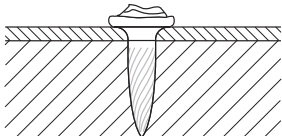
Observation	Cause	Possible remedial measures
<p><b>Nail head penetrates through material fastened (metal sheet)</b></p> 	<ul style="list-style-type: none"> <li>• Too much driving power</li> </ul>	<ul style="list-style-type: none"> <li>• Reduce power setting</li> <li>• Use lighter cartridge</li> <li>• Use nail with Top Hat</li> <li>• Use nail with washer e.g. X-U ...S12</li> </ul>
<p><b>Damaged nail head</b></p> 	<ul style="list-style-type: none"> <li>• Too much driving power</li> <li>• Wrong piston used</li> <li>• Worn-out piston</li> </ul>	<ul style="list-style-type: none"> <li>• Reduce power setting</li> <li>• Use lighter cartridge</li> <li>• Check nail-piston-combination</li> <li>• Change piston</li> </ul>

**Wrong pistons can cause all the above faults: match pistons to nails!**

Fastener	Piston	Piston tip
X-U, X-P, X-S	Use piston X-460-P8	



## 5. Nail and stud designation

## Nail designation

X-C		32	P8 S23 T	
<b>Application:</b>			<b>Washer type X (in mm):</b>	
X-ENP	Siding and Decking Nails		P	Plastic washer e.g. P8 = plastic washer Ø 8
X-ENP2K			S	Steel washer e.g. S36 = steel washer Ø 36
X-HSN	Diaphragm Decking Nails		D	Two washers
NPH	Siding and Decking Nails to Concrete		L	Two domed washers
X-U	Universal Nails		TH	Top Hat
X-P	High Performance Nail for Fastening to Concrete		THQ	Top Hat and high shear washer
X-C	Nails for Concrete and Sand lime-Masonry		MX	Collated for DX tool/ collated fasteners for GX/BX
X-S	Drywall and electrical fasteners to Steel		MXR	Collated for DX 860-ENP
X-EGN	Gas Nails for GX 120		T	For tunneling applications
X-GHP			MXR	Collated for DX 860-ENP
X-GN			T	For tunneling applications
DS	Heavy Duty Nails for Concrete and Steel		B_	For battery tools, e.g. B3
EDS	Heavy Duty Nails for Fastening Steel to Steel		G_	For gas tools, e.g. G3
X-R	Stainless Steel Nail for Fastening to Steel		<b>Dimensions:</b>	
X-CR	Stainless Steel Nails for Concrete, Sand lime Masonry and Steel. And Steel only.		Nail shank length in mm (For details, please refer to product data)	
X-CT	Nails for Forming or other Temporary uses			
DNH	DX-Kwik Nails for Concrete			
X-DKH	(pre-drilled)			

## Examples:

### X-U 52 P8

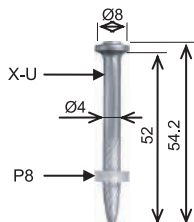

### X-U 52 MX

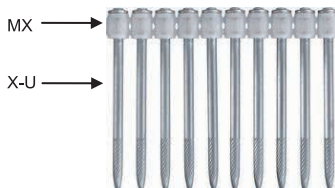



Threaded stud designation

X-M6H		10-37	FP8			
<b>Application:</b>			<b>Washer type and X (in mm):</b>			
X-M6H	DX-Kwik Threaded Studs for Concrete (pre-drilled)		P	Plastic washer e.g. P8 = plastic washer X 8		
X-M8H			S	Steel washer e.g. S8 = steel washer X 8		
X-M6		Threaded Studs for Steel		D	Two washers	
X-W6				F	Plastic guidance sleeve	
X-F7				SN12-R	Stainless steel washer for sealing purposes	
X-M8				B_	For battery tools, e.g. B3	
M10				G_	For gas tools, e.g. G3	
W10						
X-EM6H			Stainless Steel Threaded Studs			
X-EW6H						
X-EF7H						
X-EM8H						
X-EM10H						
X-EW10H						
X-BT	Stainless Steel Threaded Studs for Concrete and Steel					
X-CRM						
X-ST						
			<b>Dimensions:</b>			
			Thread Length and Shank Length in mm			

where M, W, F refer to the thread type:

M	Metric
W	Whitworth
F	French

Examples:

X-BT W10-24-6 SN12-R

X-BT M10-24-6 SN12-R

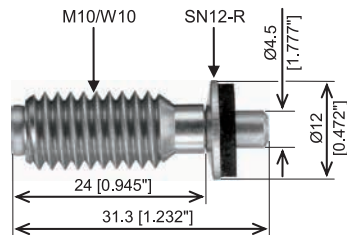

**X-BT, X-ST, S-BT Threaded studs designation**

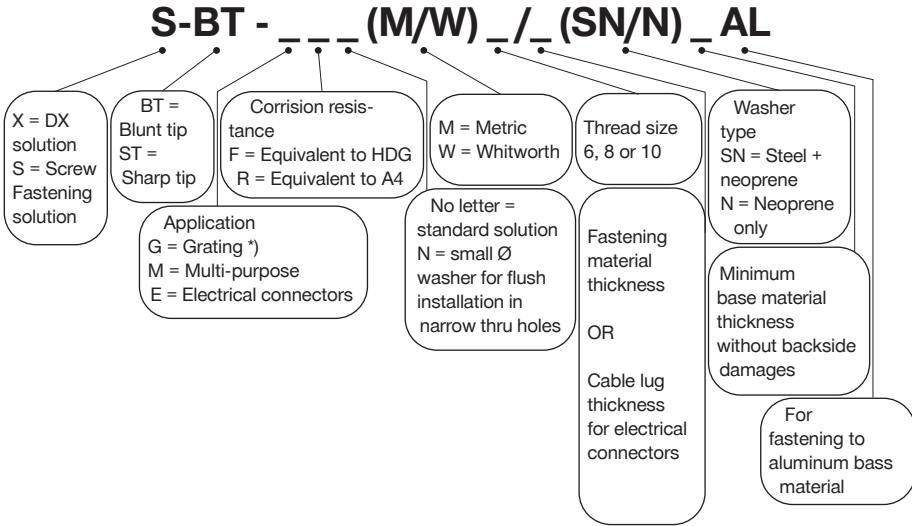

\*) X-ST-GR stainless steel threaded studs may also be used for multi-purpose applications.

**Examples**

- S-BT-MR M10/15 SN 6 AL
- S-BT-GR M8/7 SN 6
- X-BT-MF M10/10 SN 4
- X-BT-ER M8/6 SN 4

Wood nail designation

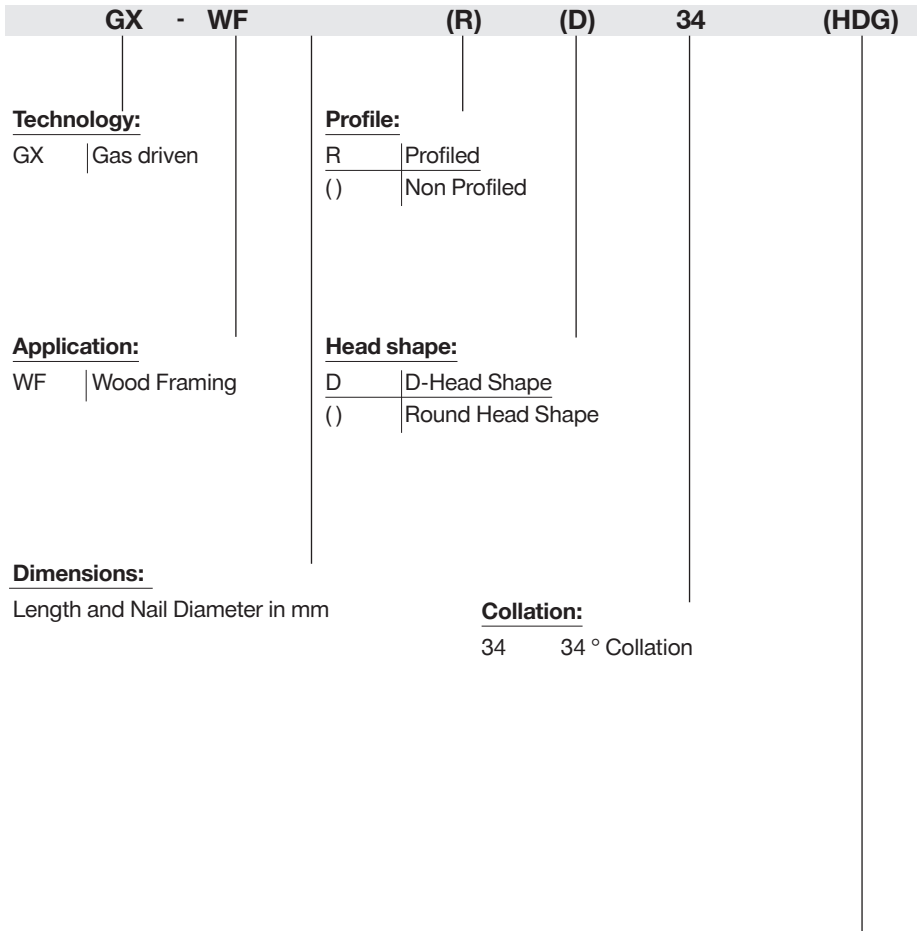

**Designation of corrosion protection on the box/label**

Suffix	Type of protection	Service Class (EN 1995-1-1)
“Bright”	no coating	1
“Galv”	12 µm zinc	1, 2
“HDG”	55 µm hot dip galvanized	1, 2, 3
“Stainless”	A2 or A4	1, 2, 3

Part 3:

## Accessories and consumables compatibility

**DX 2** Semi-automatic powder-actuated tool for fastening single nails**Fastener:**

X-X  
X-P  
X-U  
X-C  
X-CR  
X-CT  
X-M6/W6/F7/M8  
X-FS  
X-SW  
X-FB  
X-DNH  
X-DKH  
X-M6H, X-M8H  
X-HS  
X-CC  
X-CRM

**Cartridges:**

6.8/11M –  
red, yellow, green

**DX 351** Powder-actuated tool for interior finishing applications



**Fastener:**

X-P\_MX  
 X-U\_MX  
 X-C\_MX  
 X-S 13 MX

**Piston:**

X-P 8S-351

**Cartridges:**

6.8/11M –  
 red, yellow, green, white

**DX 351-F8** Powder-actuated tool for interior finishing, mechanical and electrical applications



**Fastener:**

X-P\_P8  
 X-C\_P8/TH/THP  
 X-U15 P8TH  
 X-CC-U\_P8  
 X-HS\_-U\_P8S15

**Cartridges:**

6.8/11M –  
 red, yellow, green, white

**Fastener guide:**

X-FG 8L-351  
 narrow access fastener  
 guide

**Piston:**

X-P 8L-351



X-FG 8ME-351  
 Standard fastener guide

**Piston:**

X-P 8S-351



**DX 351-BT** Powder-actuated tool for fastening X-BT threaded studs

**Fastener:**

X-BT M10-24-6 SN12-R  
 X-BT M10-24-6-R  
 X-BT W10-24-6 SN12-R  
 X-BT W10-24-6-R  
 X-BT M6-24-6 SN12-R  
 X-BT W6-24-6 SN12-R  
 X-BT-ER M10/3 SN4  
 X-BT-ER W10/3 SN4  
 X-BT-ER M8/7 SN4  
 X-BT-ER M6/7 SN4  
 X-BT-ER W6/7 SN4  
 X-BT-MF M/W 10

**Piston:**

X-351 BT P 1024

**Fastener guide:**

BT FG M1024 (M10)  
 BT FG W1024 (W10)  
 Fastener Guide dimensions  
 $b \times d \times L = 17.5 \times 22 \times 29.5 \text{ mm}$

**Cartridges:**

6.8/11M –  
 high precision - brown

**DX 351-BTG** Powder-actuated tool for fastening gratings

**Fastener:**

X-BT M8-15-6 SN12-R  
 X-BT M8-15-6-R

**Piston:**

X-351 BT P G

**Fastener guide:**

X-352 BT FG G (M8)  
 Fastener Guide dimensions  
 $b \times d \times L = 17.5 \times 22 \times 56 \text{ mm}$

**Cartridges:**

6.8/11M –  
 high precision - brown

**DX 351-CT** Fully automatic powder-actuated tool for fastening ceiling fasteners to concrete or steel

**Fastener:**

X-CW  
 X-CC  
 X-HS  
 X-U  
 X-C

**Piston:**

X-P8-351 CT

**Cartridges:**

6.8/11M –  
 red, yellow, green

**Fastener guide:**

X-FG 8ME-351  
 Standard fastener guide

## Powder-actuated tool

### DX 450 Powder-actuated tool – standard



#### Fastener guide:

45/F1

#### Fastener:

X-CR 14 D12

X-CR 16 S12

X-CR 18 S12

X-CR 21 S12

X-CR 24 S12

#### Piston:

45/NK

#### Baseplate:

45/S1

#### Cartridge:

6.8/11 M

yellow, red



- Tool is not offered by Hilti anymore.

### DX 450-FA Powder-actuated tool – facade



#### Fastener guide:

45/F5

#### Fastener:

X-R\_P8

X-CR 14 P8

X-CR 16 P8

X-CR 18 P8

X-CR 21 P8

#### Piston:

45/DNI-B

#### Baseplate:

45/S5

#### Cartridge:

6.8/11 M

yellow, red



**DX 460-MX** Powder-actuated tool for fastening collated nails



**Fastener:**

X-P\_MX  
 X-U\_MX  
 X-C\_MX  
 X-CT\_MX  
 X-ET\_MX  
 X-ECT\_MX  
 X-EKS\_MX,  
 X-FB\_MX  
 X-FS\_MX,  
 X-SW\_MX  
 X-HS\_MX  
 X-CC\_MX  
 X-HS-W\_MX  
 X-EKB\_MX

**Piston:**

X-6-5-P8  
 X-6-5-P8W  
 for fastening wood

**Cartridges:**

6.8/11M –  
 black, red, yellow, green

**DX 460-F8** Powder-actuated tool for fastening single nails



**Fastener:**

X-P\_P8  
 X-U\_P8 / P8 TH  
 X-C\_P8  
 X-CR\_P8/ P8S12  
 X-CR M8  
 X-CT\_DP8  
 X-FS, X-SW  
 X-FB  
 X-EM6H-\_-FP8  
 X-EW6H-\_-FP8  
 X-EF7H-\_-FP8  
 X-M6/W6-\_-FP8  
 X-EM8H-\_-P8  
 X-M8-\_-P8  
 X-HS, X-CC  
 X-HS-W\_P8

**Piston:**

X-6-5-P8  
 X-6-5-P8W  
 for fastening wood

**Cartridges:**

6.8/11M –  
 black, red, yellow, green

**DX-Kwik method:**

pre-drilling into concrete

**Fastener:**

X-M6H-\_-37 FP8  
 X-M8H-\_37 P8  
 X-CRM8-\_42

**Piston:**

X-6-5-PKwik

**Fastener:**

X-DNH 37 P8S15  
 X-DKH 48 P8S15

**Piston:**

X-6-5-P8

**Fastener guide:**

X-5-460-F8N15  
 Narrow access fastener  
 guide  
 (Ø 15.2 mm×53.2 mm)



**Fastener:**

X-P\_P8  
 X-C  
 X-CR\_P8  
 X-CRM\_P8  
 X-ST-GR M8\_P8

**Piston:**

X-6-5-P8

**Fastener guide:**

X-5-460-F8N10  
 Narrow access fastener  
 guide  
 (b×d×L 10.4×25.9×50 mm)



**Fastener:**

X-P\_P8  
 X-U\_P8  
 X-C  
 X-CR\_P8  
 X-CRM\_P8

**Piston:**

X-6-5-P8

**Fastener guide:**

X-5-460-F8GR  
 Grating fastener guide



**Fastener:**

X-GR  
 X-PGR-RU  
 X-ST-\_M8\_P8  
 X-EM 8H

**Piston:**

X-6-5-PGR

**Fastener guide:**

X-5-460-F8S12  
 S12 fastener guide



**Fastener:**

X-U\_S12

**Piston:**

X-6-5-P8

**Fastener guide:**

X-5-460-F8SS

8 mm stop spall fastener  
guide

**Fastener:**

X-M6-\_-\_FP8

X-W6-\_-\_FP8

X-F7-\_-\_FP8

X-M8-\_-\_P8

**Piston:**

X-6-5-P8

**Fastener guide:**

X-5-460-F10

**Fastener:**

M10 (possible)

**Piston:**

X-6-5-P10

**Fastener guide:**

X-5-460-F10SS

10 mm stop spall fastener  
guide

**Fastener:**

M10 (possible)

**Piston:**

X-6-5-P10

**Fastener guide:**

X-5-460-FIE-XL

**Fastener:**

X-IE

Insulation fastener

**Piston:**

X-6-5-PIE-XL

**DX 460-SM** Powder-actuated tool for fastening metal decks**Fastener:**

X-EDNK22-THQ12M

X-EDN19-THQ12M

X-HSN 24

**Piston:**

X-5-460-PSM

**Cartridges:**

6.8/11M –

black, red, yellow

**DX 5 MX** Digitally enabled powder-actuated tool for fastening collated nails



**Fastener:**

X-X\_MX  
 X-P\_MX  
 X-U\_MX  
 X-C\_MX  
 X-CT\_MX  
 X-ET\_MX  
 X-ECT\_MX  
 X-EKS\_MX  
 X-FB\_MX  
 X-FS\_MX  
 X-SW\_MX  
 X-HS\_MX  
 X-CC\_MX  
 X-HS-W\_MX  
 X-EKB\_MX

**Piston:**

X-6-5-P8  
 X-6-5-P8W  
 for fastening wood

**Cartridges:**

6.8/11M -  
 black, red, yellow, green

**DX 5 F8** Digitally enabled powder-actuated tool for fastening single nails



**Fastener:**

X-X\_P8  
 X-U\_P8 / P8 TH  
 X-C\_P8  
 X-CR\_P8/ P8S12  
 X-CR M8  
 X-R\_P8  
 X-ST-GR M8\_P8  
 X-CT\_DP8  
 X-FS, X-SW

X-FB  
 X-EM6H/EW6H-\_-FP8  
 X-EF7H/-\_-FP8  
 X-M6/W6-\_-FP8  
 X-EM8H-\_-P8  
 X-M8-\_-P8  
 X-HS, X-CC  
 X-HS-W\_P8

**Piston:**

X-6-5-P8  
 X-6-5-P8W  
 for fastening wood

**Cartridges:**

6.8/11M -  
 black, red, yellow, green

**DX-Kwik method:**

pre-drilling into concrete

**Fastener:**

X-M6H-\_-37 FP8

X-M8H-\_37 P8

X-CRM8-\_42

**Piston:**

X-6-5-Pkwik

**Fastener:**

X-DNH 37 P8S15

X-DKH 48 P8S15

**Piston:**

X-6-5-P8

**Fastener guide:**

X-5-460-F8N15

Narrow access fastener  
guide

(Ø 15.2 mm×53.2 mm)



**Fastener:**

X-P\_P8

X-C

X-CR\_P8

X-CRM\_P8

X-ST-GR M8\_P8

**Piston:**

X-6-5-P8

**Fastener guide:**

X-5-460-F8N10

Narrow access fastener  
guide

(b×d×L 10.4×25.9×50 mm)



**Fastener:**

X-P\_P8

X-U\_P8

X-C

X-CR\_P8

X-CRM\_P8

**Piston:**

X-6-5-P8

**Fastener guide:**

X-5-460-F8GR

Grating fastener guide



**Fastener:**

X-GR

X-PGR-RU

X-EM 8H

**Piston:**

X-6-5-PGR

**Fastener guide:**

X-5-460-F8S12

S12 fastener guide



**Fastener:**

X-U\_S12

**Piston:**

X-6-5-P8

**Fastener guide:**

X-5-460-F8SS

8 mm stop spall fastener  
guide

**Fastener:**

X-M6-\_- \_FP8

X-W6-\_- \_FP8

X-F7-\_- \_FP8

X-M8-\_- \_P8

**Piston:**

X-6-5-P8

**Fastener guide:**

X-5-460-F10

**Fastener:**

M10 (possible)

**Piston:**

X-6-5-P10

**Fastener guide:**

X-5-460-F10

10 mm stop spall fastener  
guide

**Fastener:**

M10 (possible)

**Piston:**

X-6-5-P10

**Fastener guide:**

X-5-460-FIE-XL

**Fastener:**

X-IE

Insulation fastener

**Piston:**

X-6-5-PIE-XL

**DX 5 IE** Powder-actuated tool for fastening insulation



**Fastener:**

X-IE  
insulation fasteners

**Piston:**

X-6-5-PIE-XL

**Cartridges:**

6.8/11M –  
red, yellow, green

**DX 5 GR** Powder-actuated tool for fastening gratings



**Fastener:**

X-GR  
X-PGR-RU  
X-EM 8H

**Piston:**

X-6-5-PGR

**Cartridges:**

6.8/11M –  
black, red

**DX 5 SM** Powder-actuated tool for fastening metal decks



**Fastener:**

X-EDNK22-THQ12M  
X-EDN19-THQ12M  
X-HSN 24

**Piston:**

X-5-460-PSM

**Cartridges:**

6.8/11M –  
black, red, yellow

**DX 5 F10** Powder-actuated tool for fastening threaded studs



**Fastener:**

DS\_P10  
X-EM8H-15-12 FP10  
X-EM10H-24-12 P10

**Piston:**

X-6-5-P10

**Cartridges:**

6.8/11M –  
black, red, yellow, green



**DX6 MX** Digitally enabled powder-actuated tool for fastening collated nails



**Fastener guide:**

X-6-MX72



**Fastener:**

X-X\_MX

X-P\_MX

X-U\_MX

X-C\_MX

X-CT\_MX

X-FS\_MX

X-SW\_MX

X-ET\_MX

X-ECT\_MX

X-EKS\_MX

X-FB\_MX

X-HS\_MX

X-HS-W\_MX

X-ECC\_MX

X-ECH\_MX

X-EKB\_MX

**Piston:**

X-6-5-P8

X-6-5-P8W

for wood fastening

**Cartridge:**

6.8/11 M 10 for DX 6

titanium, black

**DX6 F8** Digitally enabled powder-actuated tool for fastening single nails

## Standard fastener guide

**Fastener guide:**

X-6-F8

**Fastener:**

X-X\_P8

X-P\_P8

X-U\_P8

X-U\_P8 TH

X-C\_P8

X-CR\_P8

X-CR\_P8S12

X-CR M8

X-R\_P8

X-ST-GR M8\_P8

X-CT\_DP8

X-FS

X-DFS

X-SW

X-FB

X-EM6H-\_FP8

X-EW6H-\_FP8

X-EF7H-\_FP8

X-M6-\_FP8

X-W6-\_FP8

X-F7-\_FP8

X-EM8H-\_P8

X-M8-\_P8

X-HS

X-CC

X-HS-W\_P8

**Piston:**

X-6-5-P8

X-6-5-P8W

for wood fastening

X-6-5-P8AL

**Cartridge:**

 6.8/11 M 10 for DX 6  
 titanium, black

DX-Kwik fastener guide (DX-Kwik method/pre-drilled concrete)

**Fastener guide:**

X-6-F8



**Fastener:**

X-M6H-\_-37 FP8

X-M8H-\_37 P8

X-CRM8-\_42

**Piston:**

X-6-5-PKwik

**Cartridge:**

6.8/11 M10 for DX 6  
titanium, black

**Fastener:**

X-DNH 37 P8S15

X-DKH 48 P8S15

**Piston:**

X-6-5-P8

**Cartridge:**

6.8/11 M10 for DX 6  
titanium, black

Narrow access fastener guide (Ø: 15.2 mm, h: 53.2 mm)

**Fastener guide:**

X-6-F8N15



**Fastener:**

X-P\_P8

X-U\_P8

X-C\_P8

X-CR\_P8

X-CRM\_P8

X-ST-GR M8\_P8

**Piston:**

X-6-5-P8

**Cartridge:**

6.8/11 M10 for DX 6  
titanium, black

Narrow access fastener guide (w × t × h: 10.4 × 25.9 × 50 mm)

**Fastener guide:**

X-6-F8N10



**Fastener:**

X-P\_P8

X-U\_P8

X-C\_P8

X-CR\_P8

X-CRM\_P8

**Piston:**

X-6-5-P8

**Cartridge:**

6.8/11 M10 for DX 6  
titanium, black

Grating fastener guide

**Fastener guide:**

X-6-FGR



**Fastener:**

X-GR  
X-PGR-RU  
X-EM 8H

**Piston:**

X-6-5-PGR

**Cartridge:**

6.8/11 M10 for DX 6  
titanium, black

M10 fastener guide

**Fastener guide:**

X-6-F10



**Fastener:**

DS\_P10  
EDS 19 P10, EDS 22 P10  
X-EM8H-15-12 FP10  
X-EM10H-24-12 P10

**Piston:**

X-6-5-P10

**Cartridge:**

6.8/11 M10 for DX 6  
titanium, black

Insulation fastener guide (up to 140 mm insulation thickness)

**Fastener guide:**

X-6-FIE-L



**Fastener:**

X-IE  
XI-FV

**Piston:**

X-6-5-PIE-L

**Cartridge:**

6.8/11 M10 for DX 6  
titanium

Insulation fastener guide (up to 200 mm insulation thickness)

**Fastener guide:**

X-6-FIE-XL



**Fastener:**

X-IE  
XI-FV

**Piston:**

X-6-5-PIE-XL

**Cartridge:**

6.8/11 M10 for DX 6  
titanium

**DX6 IE** Digitally enabled powder-actuated tool for fastening insulation



**Fastener guide:**

X-6-FIE-XL

**Fastener:**

X-IE

XI-FV

**Piston:**

X-6-5-PIE-XL



**Cartridge:**

6.8/11 M10 for DX 6  
titanium

**DX6 GR** Digitally enabled powder-actuated tool for fastening grating



**Fastener guide:**

X-6-FGR

**Fastener:**

X-GR

X-PGR-RU

X-EM 8H

**Piston:**

X-6-5-PGR



**Cartridge:**

6.8/11 M10 for DX 6  
titanium, black

**DX6 F10** Digitally enabled powder-actuated tool



**Fastener guide:**

X-6-F10

**Fastener:**

DS\_P10

EDS 19 P10, EDS 22 P10

X-EM8H-15-12 FP10

X-EM10H-24-12 P10

**Piston:**

X-6-5-P10



**Cartridge:**

6.8/11 M10 for DX 6  
titanium, black

**DX76 PTR** Powder-actuated tool for fastening metal decks with collated nails



**Fastener:**  
X-ENP-19 L15 MX

**Piston:**  
X-76-P-ENP-PTR

**Piston brake:**  
X-76-PB-PTR

**Cartridges:**  
6.8/18M – black, red, blue

**Fastener:**  
X-ENP2K-20 L15 MX

**Piston:**  
X-76-P-ENP2K-PTR

**Piston brake:**  
X-76-PB-PTR

**Cartridges:**  
6.8/18M – red, blue, green

**DX76 PTR** Powder-actuated tool for fastening metal decks with single nails



**Fastener:**  
X-ENP-19 L15

**Piston:**  
X-76-P-ENP-PTR

**Fastener guide:**  
X-76-F-15-PTR

**Piston brake:**  
X-76-PB-PTR



**Cartridges:**  
6.8/18M – black, red, blue

**Fastener:**  
X-ENP2K-20 L15

**Piston:**  
X-76-P-ENP2K-PTR

**Fastener guide:**  
X-76-F-15-PTR

**Piston brake:**  
X-76-PB-PTR



**Cartridges:**  
6.8/18M – red, blue, green

**DX 76 PTR** Powder-actuated tool for fastening metal decks on concrete – DX-Kwik



**Fastener:**

NPH2-42 L15

**Piston:**

X-76-P-Kwik-PTR

**Fastener guide:**

X-76-F-Kwik-PTR

**Piston brake:**

X-76-PB-PTR



**Cartridges:**

6.8/18M – blue, yellow

**DX 76 PTR** Powder-actuated tool for fastening HVB shear connectors



**Fastener:**

X-ENP-21 HVB

**Piston:**

X-76-P-HVB-PTR

**Connector:**

X-HVB shear connectors

**Piston stop:**

X-76-PS

**Fastener guide:**

X-76-F-HVB-PTR

**Cartridges:**

6.8/18M – black, red



**DX 76 PTR** Powder-actuated tool for fastening gratings and checker plates



**Grating fastener:**

X-CRM8-15-12 P8

X-EM8H\_P8

X-ST-GR M8\_P8

**Chequer plate fastener**

X-CRM8-15-12 P8

X-CRM8-9-12 P8

X-ST-GR M8\_P8

**Fastener guide:**

X-76-F-8-GR-PTR

(Δ 19 mm×58 mm)

**Piston:**

X-76-P-8-GR-PTR

**Piston brake:**

X-76-PB-PTR

**Cartridges:**

6.8/18M –

blue, yellow

For X-GR and X-GRRU:

red, blue, yellow



**DX 76 PTR** Powder-actuated tool for fastening heavy duty applications



**Fastener:**

EDS 19 P10, EDS 22 P10

X-EM10H-24-12 P10

X-EM8H-15-12 FP10

X-CR M8-15-12 FP10

X-CR M8-9-12 FP10

DS27 – 37 P10

**Fastener guide:**

X-76-F-10-PTR

(Δ 19 mm×58 mm)

**Piston:**

X-76-P-10-PTR

**Piston brake:**

X-76-PB-PTR

**Cartridges:**

6.8/18M –

black, red, blue





**DX 76 MX** Powder-actuated tool for fastening metal decks with collated nails



**Fastener:**  
X-ENP-19 L15 MX

**Piston:**  
X-76-P-ENP

**Cartridges:**  
6.8/18M – black, red, blue

**Fastener:**  
X-ENP2K-20 L15 MX

**Piston:**  
X-76-P-ENP2K

**Cartridges:**  
6.8/18M –  
red, blue, yellow, green

**DX 76** Powder-actuated tool for fastening metal decks with single nails



**Fastener:**  
X-ENP-19 L15

**Piston:**  
X-76-P-ENP

**Fastener guide:**  
X-76-F-15

**Cartridges:**  
6.8/18M – black, red, blue



**Fastener:**  
X-ENP2K-20 L15

**Piston:**  
X-76-P-ENP2K

**Fastener guide:**  
X-76-F-15

**Cartridges:**  
6.8/18M –  
red, blue, yellow, green



**DX 76** Powder-actuated tool for fastening metal decks on concrete – DX-Kwik



**Fastener:**

NPH2-42 L15

**Piston:**

X-76-P-Kwik

**Fastener guide:**

X-76-F-Kwik

**Cartridges:**

6.8/18M – blue, yellow



**DX 76** Powder-actuated tool for fastening HVB shear connectors



**Fastener:**

X-ENP-21 HVB

**Piston:**

X-76-P-HVB

**Connector:**

X-HVB shear connectors

**Piston Stop:**

X-76-PS

**Fastener guide:**

X-76-F-HVB

**Cartridges:**

6.8/18M – black, red



**DX 76** Powder-actuated tool for fastening gratings and checker plates



**Grating fastener:**

X-CRM8-15-12 FP10

X-EM8-15-12 FP10

**Checker plate fastener**

X-CRM8-15-12 FP10

X-CRM8-9-12 FP10

**Fastener guide:**

X-76-F-10

**Piston:**

X-76-P-GR

**Cartridges:**

6.8/18M –  
black, red, blue, yellow,  
green



**DX 76** Powder-actuated tool for fastening heavy duty applications



**Fastener: (for nail)**

EDS 19 P10, EDS 22 P10

**Fastener: (for stud)**

X-EM10-24-14 P10

**Fastener guide:**

X-76-F-10  
for nails and studs

**Piston: (for nail)**

X-76-P-10

**Piston: (for stud)**

X-76-P-GR

**Cartridges:**

6.8/18M –  
black, red, blue, yellow,  
green



**DX 860-ENP** Powder-actuated tool for fastening metal decks



**Fastener:**  
X-ENP-19 L15 MXR

**Piston:**  
X-76-P-ENP

**Cartridges:**  
6.8/18M40 –  
black, red, blue

**DX 860-HSN** Powder-actuated tool for fastening metal decks



**Fastener:**  
X-EDNK22-THQ12M  
X-EDN19-THQ12M  
X-HSN 24

**Piston:**  
X-860-P10

**Cartridges:**  
6.8/11M40 –  
black, red, yellow

**DX 9-ENP** Digitally enabled powder-actuated tool for fastening metal decks



**Fastener:**  
X-ENP-19 L15 MXR

**Piston:**  
Piston X-9-ENP kit

**Nail Magazine:**  
MX 9 - ENP packed

**Cartridges:**  
6.8/18M40 –  
black, red, blue

**DX 9-HSN** Digitally enabled powder-actuated tool for fastening metal decks



**Fastener:**  
X-EDNK22-THQ12M  
X-EDN19-THQ12M  
X-HSN 24





**Piston:**  
X-9-HSN kit

**Nail Magazine:**  
MX 9 - HSN packed

**Cartridges:**  
6.8/11M40 –  
black, red, yellow

## Cartridges – Propellants for powder-actuated tools

The table below provides an overview of the main Hilti cartridges and their characteristics. For more information about cartridges and power levels, please refer to section **2.5.1 Cartridges (power loads, boosters)**.

Cartridge	Color code*	Energy scale*	Fastening tools			
			DX 2, DX 36	DX 450, DX 460, DX 462, DX 5	DX 351	DX 860-HSN <sup>1</sup>  DX 9-HSN <sup>1</sup>
6.8/11M10 and 6.8/11M40 <sup>1</sup> (.27 caliber short) 	High precision brown	2 [2]			■	
	white [brown]	2 [2]			■	
	green	3 [3]	■	■	■	
	yellow	4 [4]	■	■	■	■
	red	6 [5]	■	■	■	■
	black [purple]	7 [6]		■		■
6.8/11M10 for DX6 (.27 caliber short) 	titanium**	6 [5]	DX6			
	black	7 [6]	DX6			
6.8/18M10 (.27 caliber long) 	green	3	DX 76 / DX 76 PTR			
	yellow	4	DX 76 / DX 76 PTR			
	blue	5 [4.5]	DX 76 / DX 76 PTR			
	red	6 [5]	DX 76 / DX 76 PTR			
	black [purple]	7 [6]	DX 76 / DX 76 PTR			
6.8/18M40 (.27 caliber long) 	blue	5 [4.5]	DX 860-ENP, DX 9-ENP			
	red	6 [5]	DX 860-ENP, DX 9-ENP			
	black [purple]	7 [6]	DX 860-ENP, DX 9-ENP			
6.8/18 (.27 caliber long) 	green	3	DX 600N			
	yellow	4	DX 600N			
	red	5	DX 600N			
	black [purple]	7 [6]	DX 600N			

■ = compatible

\* Color code and energy scale according to EN 16264, in brackets according to PATMI Training Manual.

\*\* Hilti color code for DX6 cartridge stripe.



- All collated Hilti cartridges are available as Clean-Tec, environmentally-friendly heavy metal free cartridges except for 6.8/18 (.27 calibre long) for DX 600N tool.

## Gas-actuated tools

### GX 90 WF Gas-actuated tool for wood framing



#### Fastener:

- GX-WF\_
- smooth bright MX 34
- GX-WF\_
- profiled bright MX 34
- GX-WF\_
- smooth galvanized MX 34
- GX-WF\_
- profiled galvanized MX 34
- GX-WF\_
- smooth HDG MX 34
- GX-WF\_
- profiled HDG MX 34
- GX-WF\_
- profiled A2 stainless D-head

- GX-WF\_
- profiled A2 stainless full round head
- GX-WF\_
- profiled A4 stainless D-head
- GX-WF\_
- profiled A4 stainless full round head

#### Energy:

GC 32



**GX 120** Gas-actuated tool for interior finishing applications



**Fastener:**

- X-EGN 14 MX
- X-GHP 16 MX
- X-GHP 17 MX
- X-GHP 20 MX
- X-GHP 24 MX
- X-GN 20 MX
- X-GN 27 MX
- X-GN 32 MX
- X-GN 39 MX

**Energy:**

- GC20. GC 21 and GC 22



**GX 120-ME** Gas-actuated tool for mechanical and electrical applications



**Fastener:**

- X-EGN 14 MX
- X-GHP 16 MX
- X-GHP 17 MX
- X-GHP 20 MX
- X-GHP 24 MX
- X-GN 20 MX
- X-GN 27 MX
- X-GN 32 MX
- X-GN 39 MX
- X-EHS MX
- X-ECC MX
- X-HS-W MX
- X-EKB MX
- X-FB MX
- X-DFB MX
- X-ECT MX
- X-ET MX
- X-EKS MX
- X-EMTSC
- X-G M6/W6
- X-UCT MX
- X-SW 30, X-SW 60

**Energy:**

- GC20. GC 21 and GC 22





**GX 3** Gas-actuated tool for interior finishing and building construction applications



**Fastener:**

- X-S 14 G3 MX
- X-P 17 G3 MX
- X-P 20 G3 MX
- X-P 24 G3 MX
- X-C 20 G3 MX
- X-C 27 G3 MX
- X-C 32 G3 MX
- X-C 39 G3 MX
- X-M6-7-14 G3 P7
- X-M6-7-24 G3 P7
- X-W6-12-20 G3 P7
- X-W6-12-14 G3 P7

**Energy:**

GC42 for international



GC41 for use in  
North America

GC40 for use in Japan

**GX 3-ME** Gas-actuated tool for mechanical and electrical applications



**Fastener:**

- X-S 14 G3 MX
- X-P 17 G3 MX
- X-P 20 G3 MX
- X-P 24 G3 MX
- X-C 20 G3 MX
- X-C 27 G3 MX
- X-C 32 G3 MX
- X-C 39 G3 MX
- X-M6-7-14 G3 P7
- X-M6-7-24 G3 P7
- X-W6-12-20 G3 P7
- X-W6-12-14 G3 P7

**Energy:**

GC42 for international



GC41 for use in  
North America

GC40 for use in Japan

**GX 2** Gas-actuated tool for interior finishing and building construction applications

**Fastener:**

X-P 14 G2 MX
X-P 17 G2 MX
X-P 20 G2 MX
X-C 20 G2 MX
X-C 27 G2 MX
X-C 32 G2 MX
X-C 39 G2 MX

**Energy:**

GC52
------



## Gas cans

The table below provides an overview of the main Hilti gas cans and their characteristics.

Model	Number of fastenings per can	Temperature range		Fuel gauge	Tool to be used with
GC 21	750	-5°C - +50°C		Yes	GX 120
GC 22	750	-10°C - +50°C		Yes	GX 120
GC 32	1000	-10°C - +50°C		No	GX 90 - WF
GC 42	1200	-10°C - +50°C		Yes	GX 3
GC 52	1100	-10°C - +50°C		Yes	GX 2

Note: The models sold in North America and Japan have slightly different characteristics.

## Battery-actuated tools

**BX 3-BT** Battery-actuated tool for multi-purpose and electrical connection applications



### Fastener:

X-BT-MR M6/10 SN 8

X-BT-MR W6/10 SN 8

X-BT-MR M8/14 N 8

X-BT-MR M10/15 SN 8

X-BT-MR W10/15 SN 8

X-BT-ER M6/3 SN 8

X-BT-ER W6/3 SN 8

X-BT-ER M8/7 SN 8

X-BT-ER M10/7 SN 8

X-BT-ER W10/7 SN 8

X-BT M10-24-6 SN12-R

X-BT M10-24-6-R

X-BT W10-24-6 SN12-R

X-BT W10-24-6-R

X-BT-ER M10/3 SN4

X-BT-ER W10/3 SN4

X-BT-ER M8/7 SN4

### Energy:

Battery

### Fastener Guide:

X-FG B3-BT M (M6/M8/M10)

X-FG B3-BT W (W6/W10)

**BX 3-BTG** Battery-actuated tool for fastening gratings



### Fastener:

X-BT-GR M8/7 SN 8

X-BT M8-15-6 SN12-R

### Energy:

Battery

### Fastener Guide:

X-FG B3-BTG (M8 short)

**BX 3-IF** Battery-actuated tool for interior finishing and building construction applications



**Fastener:**

- X-S 14 B3 MX
- X-P 17 B3 MX
- X-P 20 B3 MX
- X-P 24 B3 MX
- X-C 20 B3 MX
- X-C 24 B3 MX
- X-C 30 B3 P7
- X-C 36 B3 P7
- X-M6-7-14 B3 P7
- X-M6-7-24 B3 P7
- X-W6-12-20 B3 P7
- X-W6-12-14 B3 P7

**Energy:**

Battery

**BX 3-ME** Battery-actuated tool for mechanical and electrical applications



**Fastener:**

- X-S 14 B3 MX
- X-P 17 B3 MX
- X-P 20 B3 MX
- X-P 24 B3 MX
- X-P 30 B3 P7
- X-P 36 B3 P7
- X-C 20 B3 MX
- X-C 24 B3 MX
- X-M6-7-24 B3 P7
- X-M6-7-14 B3 P7
- X-W6-12-20 B3 P7
- X-W6-12-14 B3 P7
- X-EHS MX
- X-ECC MC
- X-HS-W MX
- X-EKB MX

- X-FB MX
- X-DFB MX
- X-ECT MX
- X-ET MX
- X-EKS MX
- X-EMTSC MC
- X-ECH MX
- X-UCT MX
- X-DHS MX
- X-ECH FE MX
- X-EKB FE MX
- X-SW MX

**Energy:**

Battery

**BX 3 (02)** Battery-actuated tool for interior finishing applications



**Fastener:**

X-S 14 B3 MX

X-P 17 B3 MX

X-P 20 B3 MX

X-P 24 B3 MX

X-C 20 B3 MX

X-C 24 B3 MX

X-C 30 B3 MX

**Energy:**

Battery

**BX 3-L (02)** Battery-actuated tool for interior finishing applications



**Fastener:**

X-S 14 B3 MX

X-P 17 B3 MX

X-P 20 B3 MX

X-P 24 B3 MX

X-C 20 B3 MX

X-C 24 B3 MX

X-C 30 B3 MX

X-C 36 B3 MX

**Energy:**

Battery

**BX 3-ME (02)** Battery-actuated tool for mechanical and electrical applications



**Fastener:**

X-S 14 B3 MX  
 X-P 17 B3 MX  
 X-P 20 B3 MX  
 X-P 24 B3 MX  
 X-C 20 B3 MX  
 X-C 24 B3 MX  
 X-EHS MX  
 X-ECC MC  
 X-HS-W MX  
 X-EKB MX  
 X-FB MX  
 X-DFB MX

X-ECT MX

X-ET MX

X-EKS MX

X-EMTSC MC

X-ECH MX

X-UCT MX

X-DHS MX

X-ECH FE MX

X-EKB FE MX

X-SW MX

**Energy:**

Battery

**BX 3-L (03)** Battery-actuated tool for interior finishing applications



**Fastener:**

X-S 14 B3 MX  
 X-P 17 B3 MX  
 X-P 20 B3 MX  
 X-P 24 B3 MX  
 X-C 20 B3 MX  
 X-C 24 B3 MX  
 X-C 30 B3 MX  
 X-C 36 B3 MX

**Energy:**

Battery

**BX 3 (03)** Battery-actuated tool for interior finishing applications



**Fastener:**

X-S 14 B3 MX  
 X-P 17 B3 MX  
 X-P 20 B3 MX  
 X-P 24 B3 MX  
 X-C 20 B3 MX  
 X-C 24 B3 MX  
 X-C 30 B3 MX

**Energy:**

Battery

**BX 3-ME (03)** Battery-actuated tool for mechanical and electrical applications



**Fastener:**

X-S 14 B3 MX

X-P 17 B3 MX

X-P 20 B3 MX

X-P 24 B3 MX

X-C 20 B3 MX

X-C 24 B3 MX

X-EHS MX

X-ECC MC

X-HS-W MX

X-EKB MX

X-FB MX

X-DFB MX

X-ECT MX

X-ET MX

X-EKS MX

X-EMTSC MC

X-ECH MX

X-UCT MX

X-DHS MX

X-ECH FE MX

X-EKB FE MX

X-SW MX

**Energy:**

Battery