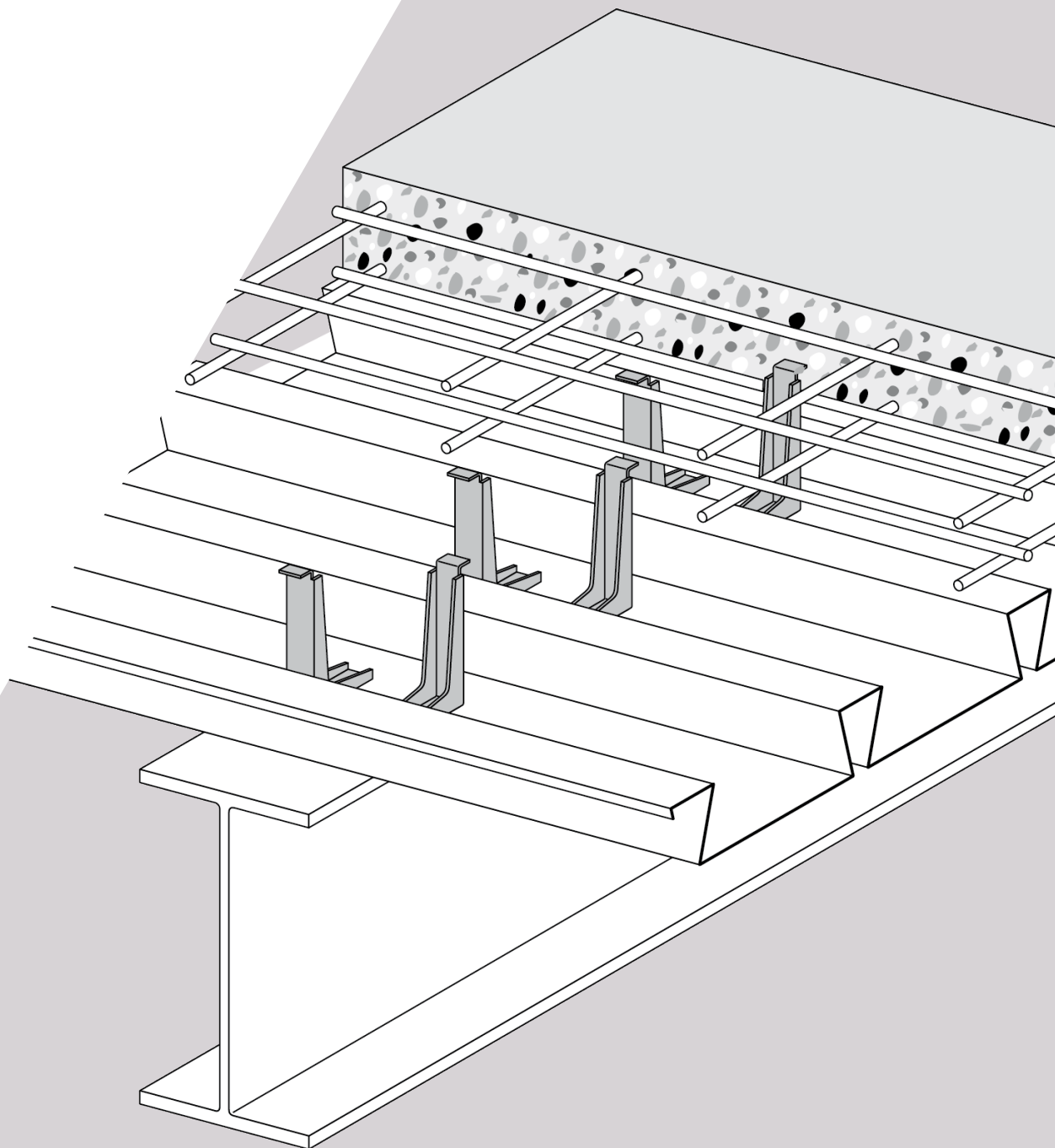




# SOLUTIONS FOR COMPOSITE BEAMS

Hilti X-HVB system



## CONTENTS

<b>1. Introduction</b>	<b>3</b>
1.1 Composite beam design	4
1.2 Types of shear connectors	6
<b>2. Hilti X-HVB system</b>	<b>7</b>
2.1 Geometry and material specifications	8
2.2 Application requirements	9
2.3 Tools and accessories	11
2.4 Cartridges	12
2.5 Fastening quality assurance	12
<b>3. Benefits and value proposition</b>	<b>13</b>
<b>4. Shear connector design according to EC4</b>	<b>16</b>
4.1 Ductility requirements	16
4.2 Distribution of shear connectors	17
4.3 Longitudinal shear force	17
4.4 Design shear resistance	18
<b>5. X-HVB positioning and spacing</b>	<b>20</b>
<b>6. Special considerations</b>	<b>21</b>
6.1 Fire resistance	21
6.2 Rehabilitation	21
6.3 Seismic response in rehabilitation	22
6.4 Deflection control	22
<b>7. References</b>	<b>23</b>
7.1 Literature	23
7.2 Hilti publications	23
7.3 Project references	23
<b>8. Annexes</b>	<b>24</b>
Annex A: Design examples	25
Annex B: Examples of commercial profiled sheeting	27
Annex C: Designation and item numbers	37

## 1. INTRODUCTION

Composite construction has dominated the multi-storey building sector for over thirty years. Its success is due to the strength and stiffness that can be achieved, with minimum use of materials.

The reason why composite construction is often the ideal solution can be expressed in one simple way: concrete is good in compression and steel is good in tension.

By joining the two materials together structurally these strengths can be exploited to result in a highly efficient and lightweight design in which the resistance may increase by up to a factor of two and the stiffness may increase by up to a factor of three. The reduced self-weight of composite elements has a knock-on effect by reducing the forces in those elements supporting them, including the foundations. Composite systems also offer benefits in terms of speed of construction. The floor depth reductions that can be achieved using composite construction can also provide significant benefits in terms of the costs of services and the building envelope.

The purpose of the X-HVB shear connector is to ensure mechanical connection between steel beams and concrete slabs. It is therefore designed to resist shear forces acting between these structural elements, promoting composite behavior.

This document is intended as a guide to the use of the Hilti X-HVB shear connector in building construction.

It shows how the calculations are made and covers the following topics:

- Characteristics of the X-HVB shear connection system,
- Benefits and value propositions of nailed shear connection,
- Shear connector design according to Eurocode 4,
- Layout of shear connectors,
- Considerations regarding fire resistance and utilization in rehabilitation projects.

The information in this document is in accordance with European Regulations.



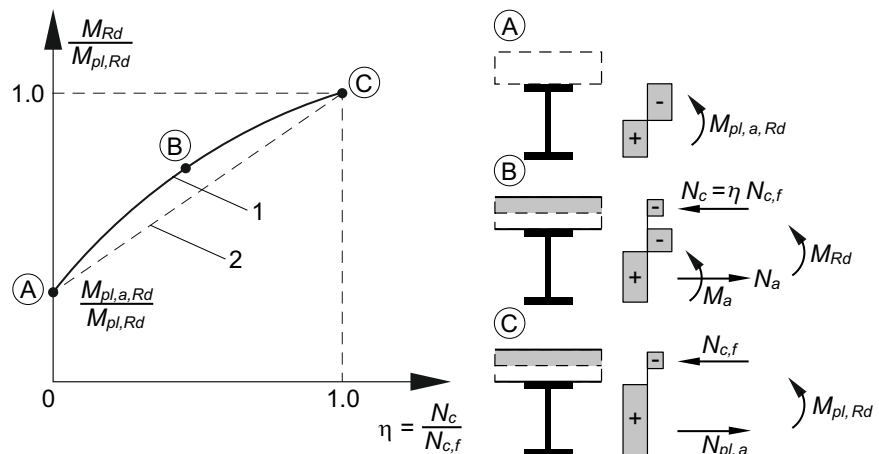
**Figure 1:** Installation of profiled sheeting for a composite slab

## 1.1 COMPOSITE BEAM DESIGN

As already mentioned, concrete is a material that works well in compression but has negligible resistance in tension. Hence for structural purposes it traditionally relies on steel reinforcement to take up any tensile forces (this is the role played by the steel part of a composite cross section, which is effectively external reinforcement), or must be pre-stressed so that even when subject to tension, an element is in net compression.

If the concrete part (within the so-called effective width) of a cross section is to carry compression, and the steel part is to carry tension, the two materials must be structurally tied together. With beams this is achieved by using shear connectors which are attached to the upper flange of the steel beam. The profiled metal decking that forms the basis of the composite slabs is sandwiched between the base of the connector and the top flange, and the welding/fixing process joins all three together.

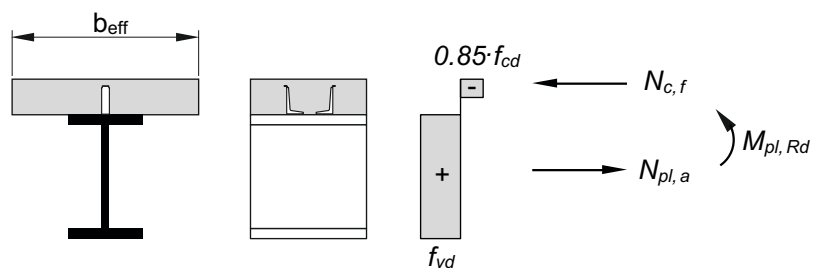
When a beam is designed with full shear connection (Figure 2-C), it means that sufficient connectors are present to either fully utilize the concrete in compression, or fully utilize the steel section in tension (whichever is the smaller force).



**Figure 2:** Degrees of shear connection, assuming plastic characteristics

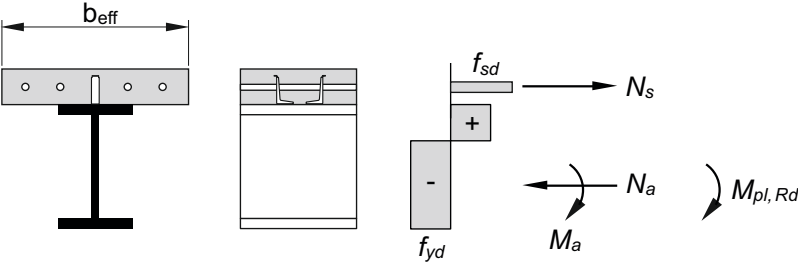
Reduced numbers of connectors may however be used, resulting in so-called partial shear connection. This usually happens if the applied loading is at a low enough level, for example, in common cases where a beam design is governed by construction stage or serviceability considerations. However, building codes also specify a certain minimum degree of connection that is needed to prevent excessive slip between the steel and concrete.

Composite beam design is especially suitable for cross-sections under positive bending moments, as concrete has good resistance to compression. If steel decking is used, the decking's resistance to compression should be neglected.



**Figure 3:** Example of plastic stress distribution for a composite beam with a solid slab and a full shear connection (positive bending moment)

Continuity of the beam can also create negative bending moments near supports. For negative bending moments, the slab's reinforcement is in tension and shear connectors must ensure that tensile force in the reinforcement is transmitted to the steel beam.



**Figure 4:** Example of plastic stress distribution for a composite beam with a solid slab and a full shear connection (negative bending moment).

Since the composite member's cross-section is larger than the beam's cross-section alone, the respective moment of inertia is higher, resulting in higher resistance to bending. These considerations allow for slimmer design of structural components. The main benefits related to composite beam design are therefore related to the fact that use of a composite section allows for savings in material and space.

In modern construction, profiled sheeting is used as permanent formwork for the concrete slab and as reinforcement for the composite deck. The decking is utilized to limit the amount of slab propping during construction.



**Figure 5:** Shear studs welded on profiled deck

## 1.2 TYPES OF SHEAR CONNECTORS

### Welded shear studs

Welded shear studs are a traditional type of shear connector. Typically, welded shear studs exhibit ductile behavior and have good resistance to horizontal shear and vertical uplift, i.e. horizontal shear is resisted by the shank and vertical uplift is prevented by the head.

When steel decking is used, either the studs are welded through the decking or the decking is perforated and pre-welded studs are fitted through the perforations.

Inherent concerns related to welding are as follows:

- welding requires skilled/experienced labor,
- quality control checks may be ambiguous, i.e. visual inspection, sound produced when hammered, bending test,
- equipment required on site, resulting in transportation costs and effort,
- numerous electric cables required, which may lead to tripping hazards,
- welding quality is largely dependent on beam surface conditions, i.e. humidity, rust, etc.,
- welds on wrought iron beams might be brittle and not effective,
- direct welding onto galvanized beams may cause health issues,
- finishing work is necessary after welding on coated/painted beams,
- sites with fire regulations (fire watch) may restrict hot works, i.e. welding.



**Figure 6:** Hilti X-HVB installed on profiled deck

### Hilti X-HVB shear connector

The Hilti X-HVB shear connector is an L-shaped shear connector which is fastened to a beam with two nails driven by a powder-actuated tool. The X-HVB is ductile in all sizes and designed to resist longitudinal shear force, while vertical uplift is prevented by the X-HVB head and the nails.

It is suitable for use at the connection between concrete slabs and steel beams with or without steel decking. As the X-HVB is fastened using the Hilti direct fastening technique, its great versatility allows it to be used in situations where welded studs are not applicable and/or not effective.

The X-HVB system does not require electric power, has an easy and approved inspection procedure and, unlike welding, it is not weather dependent and does not infringe site hot works, i.e. fire-watch, regulations. X-HVB placement is also not sensitive to the beams' surface treatment.

Typical features of the X-HVB are:

- simple, inexpensive installation equipment,
- fastening quality largely independent of weather conditions,
- fast installation allows flexible scheduling of work on the jobsite,
- zinc coatings or moisture do not affect the fastening quality.

When retrofitting/renovating older buildings, i.e. rehabilitation projects, the X-HVB shear connector is fastened to old existing beams that will support newly cast slabs. This method is used in flooring systems for rehabilitation purposes, mostly subjected to static loading.

The main advantages of using the rehabilitation technique are the increase in bending resistance and the decrease in deformability/deflection, hence the ability to adapt structures to modern load requirements and usage.

## 2. HILTI X-HVB SYSTEM

The X-HVB system is an effective and efficient solution for secure shear connection. Direct fastening technology makes this shear connector easy to install since it can be set securely and reliably by workmen with simple training.

X-HVB shear connectors are fastened to steel components, typically the top flange of a steel beam, using a Hilti DX 76 (or DX 76 PTR) tool equipped with accessories specifically for this purpose. The nail-driving energy is provided by Hilti DX cartridges (powder-actuated system).

As no welding is required, the X-HVB system can be installed under almost any site conditions. In addition, fastening quality assurance is provided by an easy and approved inspection process.

The system comprises the following items:

- X-HVB shear connector, available in different heights,
- X-ENP-21 HVB nails, two for each X-HVB shear connector,
- 6.8/18M cartridges, black, red or blue,
- DX 76 (or DX 76 PTR) tool equipped for X-HVB installation,
- X-ENP-21 HVB check gauge, power-adjustment.



Figure 7: Hilti X-HVB shear connector



Figure 8: X-ENP-21 HVB nail

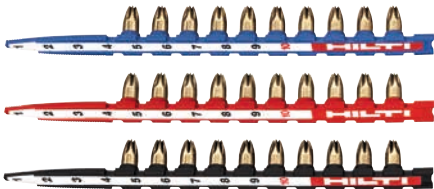


Figure 9: Black, red and blue cartridges



Figure 10: DX 76 HVB tool

The L-shaped shear connectors are cold formed from steel and comprise the fastening leg, the anchorage leg and the head. The anchorage leg is cast into the concrete while the fastening leg is fastened to the steel beam with two X-ENP-21 HVB nails (Figure 11).

The shear connectors are available in seven different anchorage leg heights for different steel decking and slab configurations (detailed geometry in next chapter). Note that X-HVB 40 and X-HVB 50 are used specifically for thin slabs without profiled sheeting.

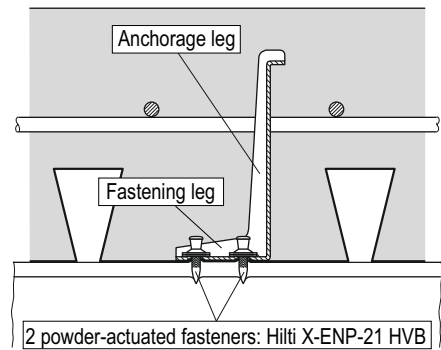
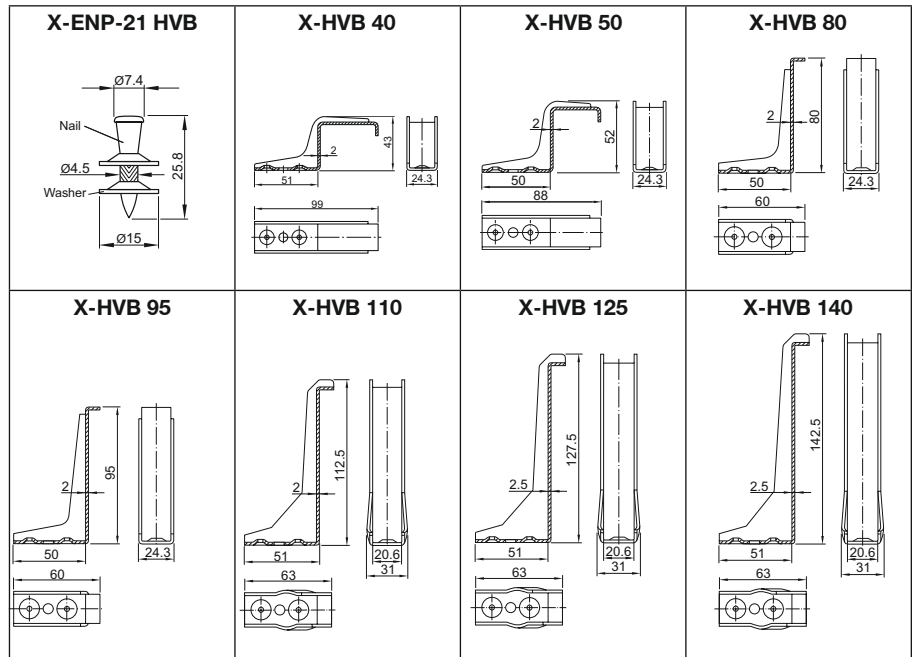


Figure 11: Hilti X-HVB in composite beam

## 2.1 GEOMETRY AND MATERIAL SPECIFICATIONS

The dimensions and material specifications for the various shear connectors are shown and listed in the following illustrations and table.



**Figure 12:** Dimensions of X-ENP-21 HVB fastener and X-HVB shear connectors

Designation	Material
X-HVB shear connector	Non-alloy quality steel DC04, as per EN 10130 Zinc plating: $\geq 3 \mu\text{m}$
X-ENP-21 HVB nail	Carbon steel C67S, as per EN 10132-4, quenched, tempered and galvanized - nominal hardness: 58 HRC Zinc plating: $\geq 8 \mu\text{m}$
X-ENP-21 HVB washer	Non-alloy quality steel DC01, as per EN 10139 Zinc plating: $\geq 10 \mu\text{m}$

**Table 1:** X-HVB and X-ENP-21 HVB material specifications



## 2.2 APPLICATION REQUIREMENTS

The X-HVB system is intended to provide the connection between steel and concrete in composite beams and composite decks according to EN 1994-1-1, either in new buildings or for the renovation of existing buildings, in dry/indoor conditions.

In order to ensure that the system functions correctly, the following factors must be taken into account:

### Type of loading

X-HVBs may be used for shear connection in composite structures subject to static and quasi-static loading.

As the X-HVB is a ductile shear connector according to EN 1994-1-1, section 6.6, seismic loading is covered if the X-HVB is employed as the shear connector in composite beams used as secondary seismic members in dissipative as well as non-dissipative structures according to EN 1998-1.

### Base material

X-HVBs may be used for shear connection on structural steel S235, S275 and S355 in qualities JR, JO, J2, K2 according to EN 10025-2, with a minimum thickness of 6 mm (for details, please refer to the European Technical Assessment ETA-15/0876).

Old steels which cannot be classified accordingly are still suitable provided these consist of unalloyed carbon steel with minimum yield strength  $f_y$  of 170 N/mm<sup>2</sup>.

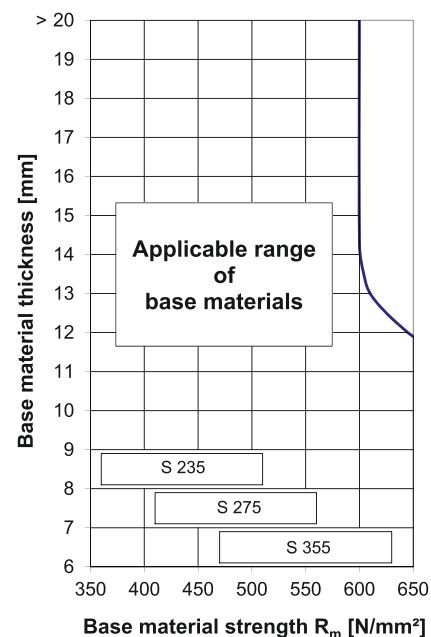
### Coating

In combination with composite decking the steel sheeting is in direct contact with the steel base material in the area of the connection. The beams may be hot-dipped galvanized, paint coated or coated with a primer with a coating thickness up to approximately 160  $\mu\text{m}$ . The contact surface of the beam may not be covered with intumescent reactive fire coating.

### Concrete class

X-HVBs may be used for shear connection with the following concrete classes:

- Normal-weight concrete C20/25 – C50/60
- Light-weight concrete LC20/22 – LC50/55, with a raw density  $\rho \geq 1750 \text{ kg/m}^3$   
For density between 1750 and 1400  $\text{kg/m}^3$  a reduced design resistance for the shear connector should be considered – Please contact your Hilti local office for more information.



**Figure 13:** Base material application limit

### Concrete cover

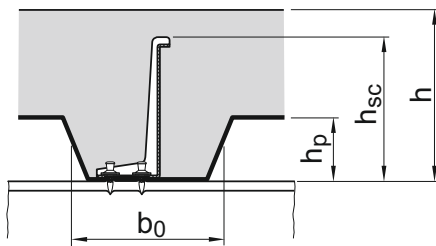
As specified in EN1994-1-1, section 6.6.5.2, if concrete cover is required (exposure class as identified in EN1992-1-1, table 4.1), the nominal concrete cover can be 5 mm less than the values in EN1992-1-1, table 4.4 but not less than 20 mm.

If concrete cover is not required, the code allows for the top of the shear connector to be flush with the top of the concrete slab. Recommended concrete slab thicknesses for the different X-HVBs are listed in Table 2.

Designation	Minimum slab thickness h	
	Without corrosion effect	With corrosion effect
X-HVB 40	50 mm	60 mm
X-HVB 50	60 mm	70 mm
X-HVB 80	80 mm	100 mm
X-HVB 95	95 mm	115 mm
X-HVB 110	110 mm	130 mm
X-HVB 125	125 mm	145 mm
X-HVB 140	140 mm	160 mm

**Table 2:** Minimum slab thickness

### Profiled sheeting



**Figure 14:** Profiled sheeting geometry

X-HVBs may be used for shear connection in composite beams with or without profiled sheeting.

With profiled sheeting, the following values for the maximum total thickness of the profiled sheeting must be taken into account:

- 2.0 mm, for X-HVB 80, X-HVB 95 and X-HVB 110
- 1.5 mm for X-HVB 125 and X-HVB 140

Designation	Maximum decking height h <sub>p</sub> dependent on decking geometry		
	$\frac{b_0}{h_p} \geq 1.8$	$1.0 < \frac{b_0}{h_p} < 1.8$	$\frac{b_0}{h_p} \leq 1.0$ <sup>1</sup>
X-HVB 80	45 mm	45 mm	30 mm
X-HVB 95	60 mm	57 mm	45 mm
X-HVB 110	75 mm	66 mm	60 mm
X-HVB 125	80 mm	75 mm	73 mm
X-HVB 140	80 mm	80 mm	80 mm

**Table 3:** Maximum profiled sheeting height dependent on decking geometry

<sup>1</sup>  $b_0/h_p \geq 1.0$  for profiled sheeting perpendicular to the beam combined with X-HVB orientation parallel with the beam

### 2.3 TOOLS AND ACCESSORIES

Hilti supplies the DX 76 HVB tool which is already suitably equipped to fasten X-HVBs (**Figure 15** and **Figure 16**). In addition, the DX 76 and DX 76 PTR tools can be used. In this case, the fastener magazine has to be replaced with the required piston and fastener guide for X-HVB installation. **Table 3** gives an overview.



**Figure 15:** DX 76 HVB



**Figure 16:** DX 76 PTR HVB



**Figure 17:** DX 76 tool



**Figure 18:** DX 76 PTR tool



**Figure 19:** DX 76 fastener guide



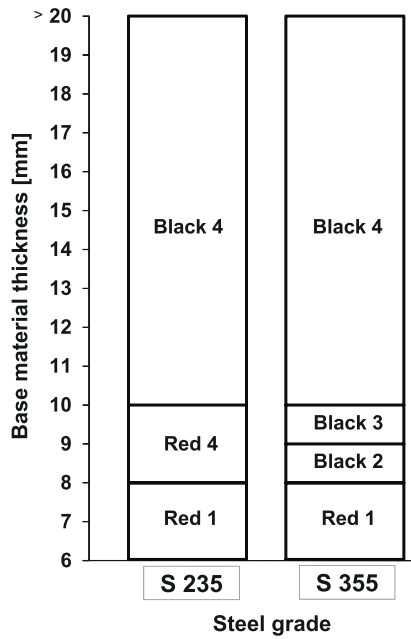
**Figure 20:** DX 76 PTR fastener guide



**Figure 21:** DX 76 piston and X-76-PS piston stopper



**Figure 22:** DX 76 PTR piston and X-76-PS piston stopper



**Figure 23:** Cartridge pre-selection and power setting

## 2.4 CARTRIDGES

The DX 76 and DX 76 PTR tools use 6.8/18 M10 cartridges. The type of cartridge, black, red or blue, is dependent on steel beam strength and thickness (**Figure 23**).

For thin base material, from 6 to 8 mm thickness, red cartridges and power setting 1 are recommended (blue cartridges may also be suitable in some cases).

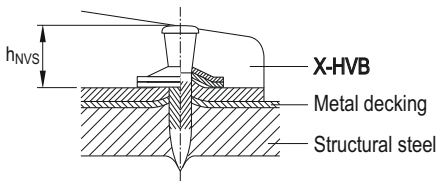
If necessary, increase the power setting until the correct fastener stand-off is achieved (refer to the chapter **Fastening quality assurance**).

Based on the cartridge recommendations, fine adjustments can be made by carrying out nail-driving tests on site. If nail standoff lies between 8.2 and 9.8 mm after the nail is driven, the cartridge and the tool power settings are considered appropriate for the base material.

Specifically designed check gauge for nail stand-off (**Figure 23 b**) is available from Hilti.

Color code	Power level
Black	Extra high
Red	Medium-high
Blue	Medium

**Table 4:** Color code and power level

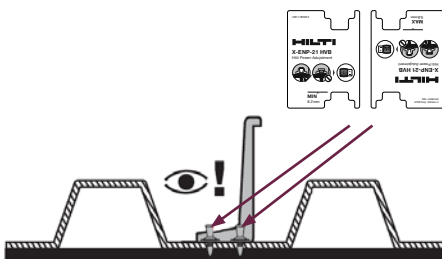


**Figure 24:** Nail top washer

## 2.5 FASTENING QUALITY ASSURANCE

The primary means of checking the quality of the nail fastening is a visual check of the nail top washer (**Figure 24**) and nail stand off  $h_{NVS}$  measurement with the support of the dedicated X-HVB checking gauge. Each X-ENP 21 nail box contains a power adjustment gauge to support the correct installation process: by placing the gauge on the installed nails it is easy to check the nail standoff and to determine if a power adjustment on the tool is required. (**Figure 24a**).

The visual appearance of the top washer and the nail stand-off  $h_{NVS}$  indicates how the tool power setting should be adjusted (**Table 5**).



**Figure 24a:** Nail Stand off

Visual appearance	Checking gauge visual check	Corresponding nail stand off	Adjustment required
Heavy piston mark on washer, washer damaged		$h_{NVS} < 8.2 \text{ mm}$	Reduce energy and/or use lighter cartridge
Slight piston mark on washer, washer compressed, two washer are connected		$8.2 \leq h_{NVS} \leq 9.8 \text{ mm}$	No adjustment: cartridge and power setting are correct
Top washer undeformed, washers are separated		$h_{NVS} > 9.8 \text{ mm}$	Increase power setting or use heavier cartridge

**Table 5:** Fastening inspection and nail stand-off

### 3. BENEFITS AND VALUE PROPOSITION

An optimal composite structure is one that exploits the benefits of both materials, in a truly unified structural system that overcomes the drawbacks of each material taken individually.

The main advantages of steel are:

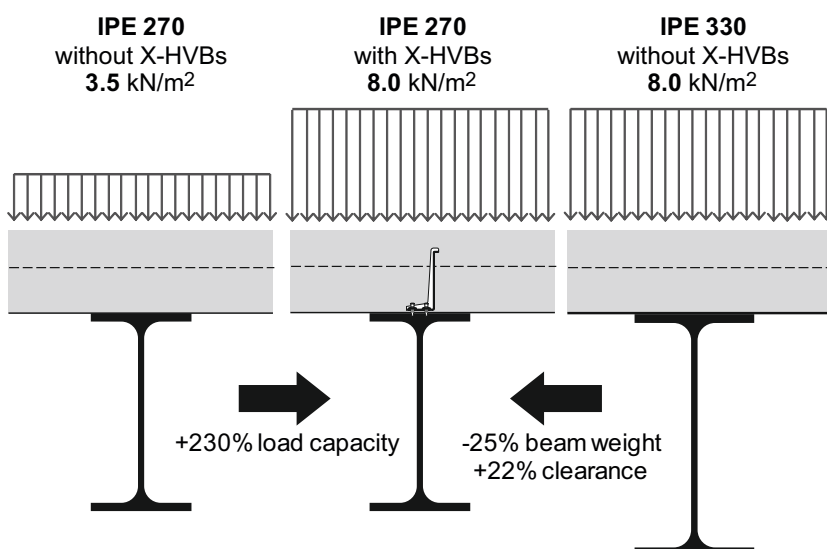
- high strength / weight ratio, which leads to a significant reduction of forces acting on the foundation,
- ductility of the material, which makes it especially useful in seismic areas,
- ability to easily use self-supporting profile decks and casting finishing concrete,
- possibility of realizing large spans,
- speed of construction,
- ease of structural changes and subsequent additions.

The advantages of concrete may include:

- the excellent compression behavior, enhanced by the increasing use of high-strength concrete, makes it possible to design elements characterized by smaller cross sections,
- reduced instability and deformability due to the increased stiffness of the elements,
- good performance under exposure to fire,
- moldability of the structural elements.

The combination of these inherent characteristics makes it possible to simply define the main structural advantages of steel/concrete composite structures:

- excellent static performance in terms of strength, stiffness and ductility,
- reduction of local and global instability issues,
- excellent performance in case of fire,
- good speed of construction.



**Figure 25:** Example of the resulting benefits, taking the following parameters into account:

- beam: 6.0 m span, 2.0 m spacing, S275, unpropped during construction phase
- slab: 0.11m thickness, C25/30
- profiled decking: Hi-Bond 55/800

A further advantage, typical of steel structures, is related to the possibility of making openings in the beam web, which allows a more rational and less invasive distribution of the installations. This is extremely important for production and supply services facilities.

Major benefits of the X-HVB system, compared to traditional welded shear studs, can be listed as follows:

- does not infringe site hot works, i.e. fire-watch, regulations,
- easy and approved inspection method,
- avoids pre-punching of steel decking which enables longer spans and less propping,
- can be installed on coated and painted beams without need for subsequent finishing,
- does not require use of welding equipment and generators, i.e. no equipment transportation to/from and on site,
- installation quality is independent of site conditions, i.e. moisture after rain, light surface rust, etc.

The X-HVB system therefore supports fast construction assembly especially:

- where welded shear studs are pre-welded on primary beams in the yard/shop (ideal welding conditions) and shear connectors are required to be installed on secondary beams on site using the Hilti direct fastening method,
- in case of limited transportation and crane access,
- in remote areas.

**Figure 26:** Installation phases for X-HVBs on profiled sheeting (from top left clockwise):

- laying profiled sheeting on steel beams,
- installing of X-HVBs through profiled sheeting,
- laying welded mesh reinforcement,
- pouring the concrete.



The following can be considered as the main benefits of using composite structures in rehabilitation.

### Increasing the load-bearing capacity

Renovation projects often originate from requirements related to the change of intended use of the building, for example from house premises to offices, with the consequence of higher loads transferred to the floor (both permanent and variable loads). It is therefore necessary to structurally strengthen the floor, thereby making the structure compatible with the new load-bearing capacity requirement.

### Improvement of the flexural behavior

Older existing building slabs are generally designed for modest live loads, far below the values prescribed by current regulations in relation to the new intended use of the structure. A higher stiffness is generally required, both to prevent damage to the partition walls and floors, and to improve occupancy comfort, limiting vibrations due to trampling and improving soundproofing.

The immediate effect is not only improved flexural stiffness of the slab due to the beams no longer working separately, but also the creation of a monolithic structure that improves overall stiffness thanks to interconnection with the new composite slab.

### Improvement of the technical performance

Reinforcement of existing slabs using the composite slab technique results in other significant benefits to the properties of the floor.

- **Sound insulation**

The creation of a new concrete slab, combined with a specific acoustic mat and, where possible, with a finishing screed, significantly improves performance in terms of the apparent sound reduction index for airborne noise and the normalized impact noise level for structure-borne noise.

- **Thermal insulation**

The use of lightweight solutions, in addition to improving the static behavior of the slab, ensures an increase in the thermal insulation of the horizontal partition. In fact, structural lightweight concrete in conjunction with light finishing screeds, by virtue of low thermal conductivity, contributes to the improvement of the thermal transmittance of the entire horizontal partition.

- **Fire protection**

The presence of a new concrete slab improves the fire behavior of the floor thanks to the presence of a layer filled with fireproof insulating material.



**Figure 27:** Example of rehabilitation where X-HVBs are installed on existing old beams

## 4. SHEAR CONNECTOR DESIGN ACCORDING TO EC4

### 4.1 DUCTILITY REQUIREMENTS

According to EN1994-1-1 section 6.6.1, shear connection and transverse reinforcement is to be provided in order to transmit the longitudinal shear force between the concrete and the structural steel element, ignoring the effect of a natural bond between the two.

In order to allow any inelastic redistribution of shear assumed in design (i.e. plastic analysis), connectors are required to have sufficient deformation capacity, namely, their characteristic slip capacity  $\delta_{uk}$  must be at least 6 mm.

Where plastic stress distribution is taken into account in the beams, Eurocode 4 allows partial shear connection limited to 0.4 to be taken into account. The degree of shear connection is calculated as follows:

$$\eta = N_c / N_{c,f}$$

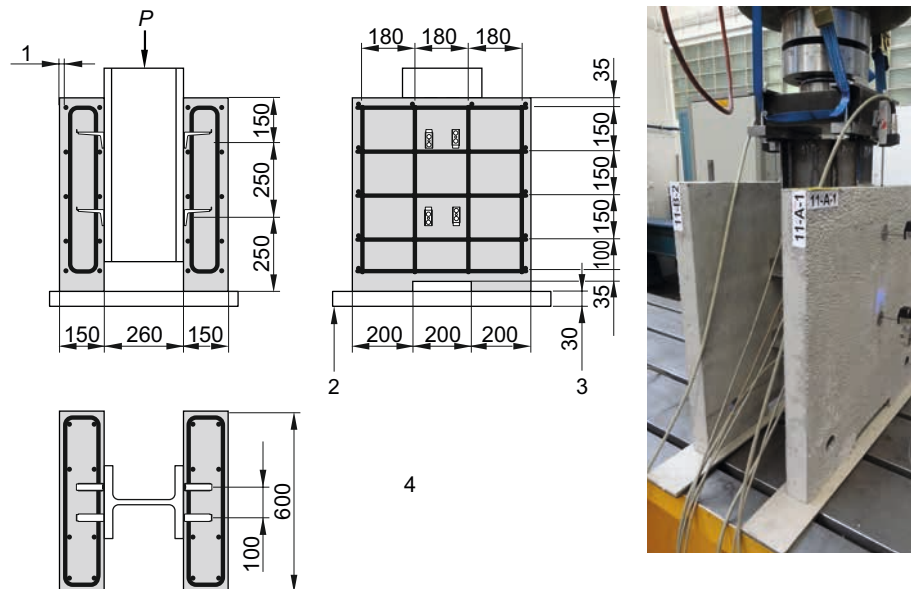
Where

- $N_c$  is the design value of the compressive force in the concrete,
- $N_{c,f}$  is the design value of the compressive force in the concrete with full shear connection.

The ductility of a shear connection is tested with push-out tests as defined in EN1994-1-1 section B2 guidelines, with the setup shown in **Figure 28**.

**Figure 28:** (from left to right):

- standard push-out test setup according to EN 1994-1-1
- example of push-out specimen with X-HVB 40 installed in shallow solid slab



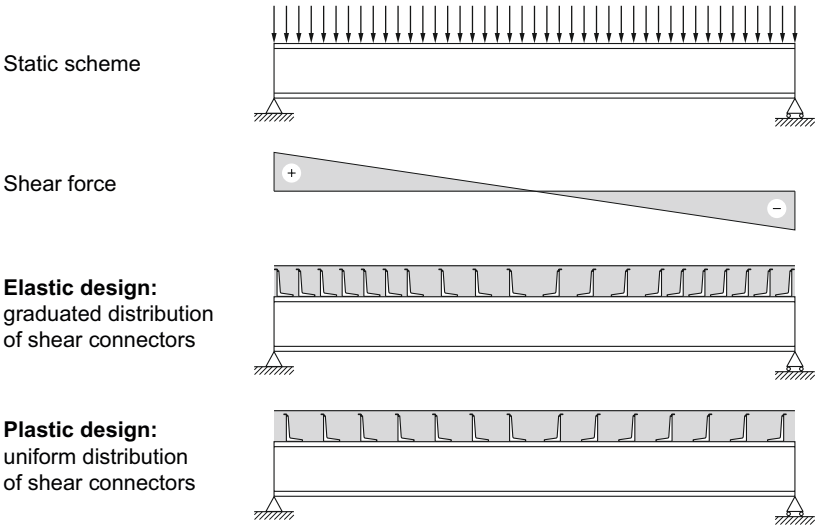
Test results have shown that Hilti X-HVB shear connectors are ductile in all sizes and therefore meet Eurocode 4 requirements for connections with plastic properties.



### 4.2 DISTRIBUTION OF SHEAR CONNECTORS

If elastic design is required, the shear connectors are distributed along the beam according to shear loads, i.e. higher shear loads near the supports or concentrated load are resisted by closer spacing of shear connectors. Such distribution ensures that each connector carries an equal share of the longitudinal shear force acting on the beam (Figure 29).

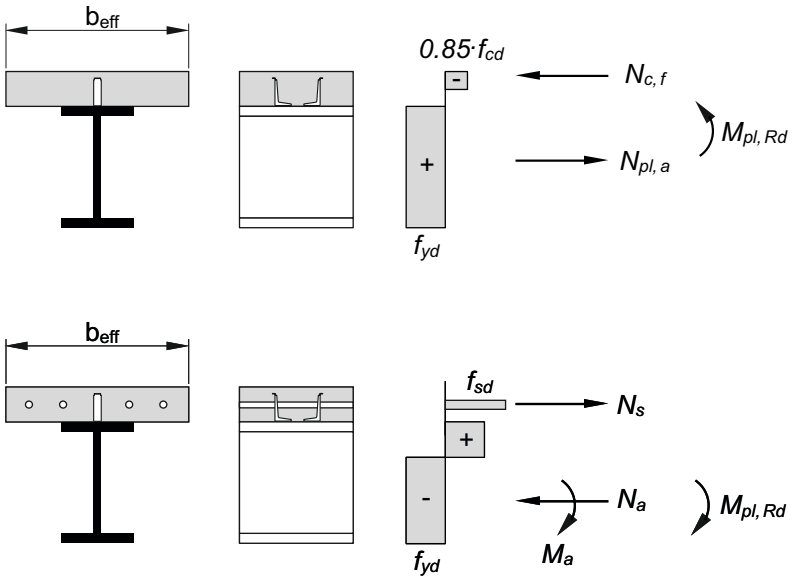
In case of plastic design, the shear connectors are distributed equally and uniformly along the beam, as the load is redistributed by the shear connectors. The shear connector used must fulfill the ductility requirements of the applicable section of Eurocode 4.



**Figure 29:** Graduated versus uniform distribution of shear connectors for a simply supported beam with distributed load.

### 4.3 LONGITUDINAL SHEAR FORCE

Shear connectors are designed to resist the longitudinal shear forces (as per stress distribution of the cross sections) in the horizontal plane between the concrete slab and top flange of the steel beam.



**Figure 30:** Typical plastic stress distributions for positive and negative bending moments

In case of plastic design, the full shear connection capacity, developed between the support and the center of the beam, must be equal to or greater than the design compressive force  $N_{c,f}$  (in case of simple supported beam with uniform load applied). Therefore, in full shear connection, the number of shear connectors to be used is determined by the design longitudinal shear force of the beam divided by the design shear resistance of single shear connector.

## 4.4 DESIGN SHEAR RESISTANCE

The loadbearing capacity of the X-HVB, i.e the shear resistance in a solid concrete slab, is the combined result of:

- hole elongation in the fastening leg of the connector,
- local deformation of the base steel plus bending of the nails,
- bending of the X-HVB,
- and local deformation of concrete in the contact zone with the connector.

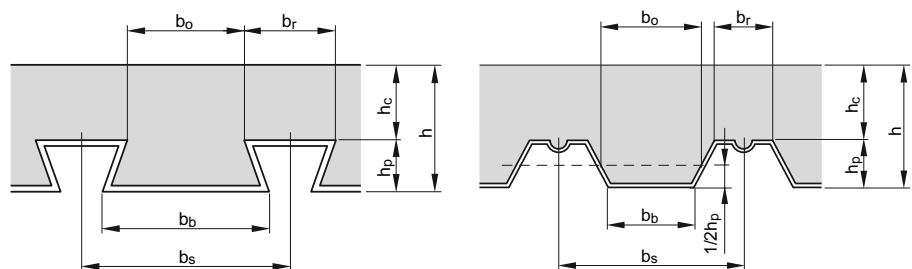
For composite beams with solid slabs, characteristic and design resistances are listed in **Table 6**.

**Table 6:** Characteristic and design resistance in solid slabs

Designation	Characteristic resistance $P_{Rk}$	Design resistance $P_{Rd}$
X-HVB 40	29.0 kN	23 kN
X-HVB 50	29.0 kN	23 kN
X-HVB 80	32.5 kN	26 kN
X-HVB 95	35.0 kN	28 kN
X-HVB 110	35.0 kN	28 kN
X-HVB 125	37.5 kN	30 kN
X-HVB 140	37.5 kN	30 kN

When profiled sheeting is present, the shear resistance of the X-HVB is calculated by multiplying the shear resistance without steel decking with reduction factors that are dependent on decking orientation and profile geometry.

**Figure 31:** Profiled decking geometries for open-trough and re-entrant profiles



### Decking ribs parallel to the beam axis

In case of profiled sheeting with ribs parallel to supporting beam, the design shear resistance of the X-HVB ( $P_{Rd}$ ) must be multiplied by the reduction factor  $k_1$  given by the following expression:

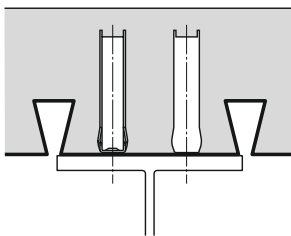
$$k_1 = 0.6 \cdot \frac{b_0}{h_p} \cdot \left( \frac{h_{sc}}{h_p} - 1 \right) \leq 1.0$$

where,

- $b_0$  is the width of the steel decking profile
- $h_p$  is the height of the steel decking profile
- $h_{sc}$  is the height of the X-HVB

Hence, the design shear resistance must be considered as

$$P_{Rd,1} = k_1 \cdot P_{Rd}$$



**Figure 32:** Profiled sheeting parallel to the beam axis

### Decking ribs transverse to the beam axis

In case of profiled sheeting with ribs transverse to supporting beam, the design shear resistance of the X-HVB ( $P_{Rd}$ ) is influenced also by the orientation of the shear connector in relation to the beam axis.

In case of X-HVB positioned longitudinally to the beam axis, the reduction factor  $k_{t,l}$  is as follows:

$$k_{t,l} = \frac{0.66}{\sqrt{n_r}} \cdot \frac{b_0}{h_p} \cdot \left( \frac{h_{sc}}{h_p} - 1 \right) \leq 1.0$$

Where  $n_r$  corresponds to the number of X-HVBs per rib.

In this case, the design shear resistance must be considered as

$$P_{Rd,t,l} = k_{t,l} \cdot P_{Rd}$$

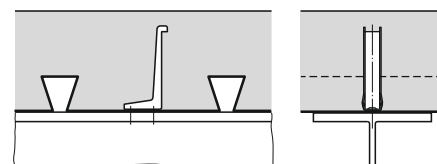
In case of X-HVB positioned transversely to the beam axis, the reduction factor  $k_{t,t}$  is as follows:

$$k_{t,t} = \frac{1.18}{\sqrt{n_r}} \cdot \frac{b_0}{h_p} \cdot \left( \frac{h_{sc}}{h_p} - 1 \right) \leq 1.0$$

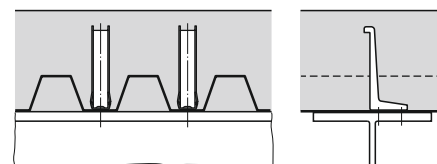
And the design shear resistance is

$$P_{Rd,t,t} = 0.89 \cdot k_{t,t} \cdot P_{Rd}$$

For more details please refer to the relevant annexes in ETA and check the technical specifications of the Shear Connector Design software (<https://shearconnectordesign.hilti.com/>).

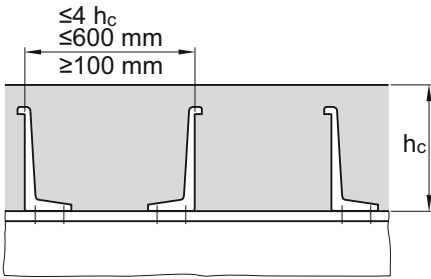


**Figure 33:** Profiled sheeting transverse to the beam axis, X-HVB parallel



**Figure 34:** Profiled sheeting transverse to the beam axis, X-HVB transverse

## 5. X-HVB POSITIONING AND SPACING

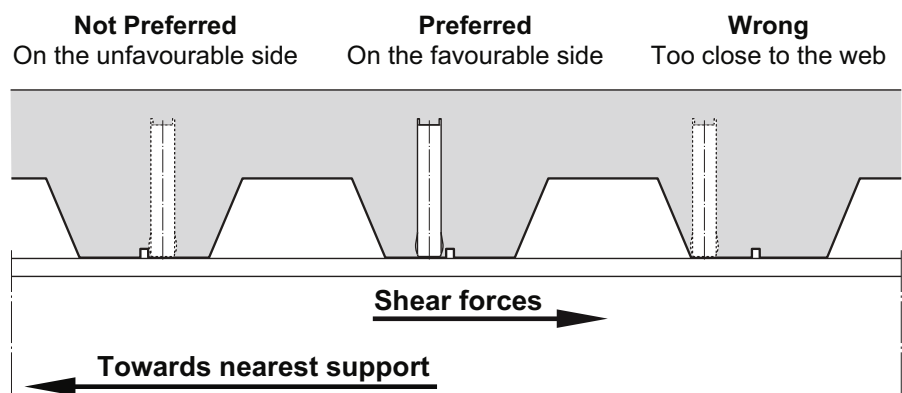


**Figure 35:** Positioning in solid concrete slab with one row of X-HVB

In composite beams with solid concrete slabs or with profiled sheeting parallel with the beam, the X-HVBs must be positioned parallel with the beam axis and opposing each other (**Figure 35**).

In composite beams with profiled sheeting transverse with the beam, the X-HVBs may be positioned parallel or transverse with the beam axis.

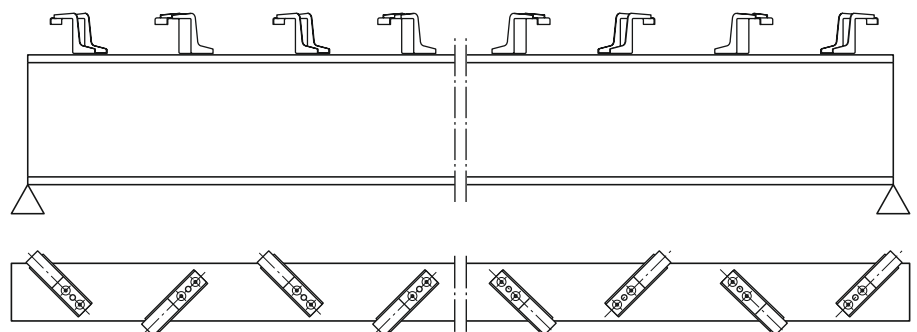
Since load transfer between X-HVBs and the slab is accomplished predominantly by a concrete strut, when profiled decking has narrow ribs and/or stiffeners, the X-HVB should be positioned on the favorable side of the rib, which is towards the nearest beam support, as per **Figure 36**, to allow sufficient load transfer.



**Figure 36:** Positioning with profiled sheeting and X-HVBs transverse with the beam

In rehabilitation projects with thin concrete solid slabs, it is necessary to use “duck walk” positioning, i.e. the center of the X-HVB base is positioned on the center line of the beam’s top surface and the X-HVBs are positioned alternately obliquely to the longitudinal axis of the beam.

In the event of uniformly distributed loads, as is often the case, the X-HVBs are positioned symmetrically with the heads pointing towards the nearest support (**Figure 37**).



**Figure 37:** Positioning in solid concrete slab with one row of X-HVB

**For detailed information on positioning, spacing and edge distances to be considered, refer to “ETA-15/0876”.**

## 6. SPECIAL CONSIDERATIONS

### 6.1 FIRE RESISTANCE

The temperature-dependent characteristic shear resistance of X-HVB shear connectors in a solid slab, in the fire situation, should be determined according to the following expression:

$$P_{fi,Rd} = k_{u,\theta,X-HVB} \cdot \frac{P_{Rk}}{\gamma_{M,fi}}$$

Where

- $P_{Rk}$  is the characteristic shear resistance of X-HVB, as provided in ETA-15/0876,
- $\gamma_{M,fi}$  is the partial safety factor for shear resistance for the fire situation (as stated in EN 1994-1-2, section 2.3, the recommended value for  $\gamma_{M,fi}$  is 1),
- $k_{u,\theta,X-HVB}$  is the temperature dependent strength reduction factor given in the following table.

Temperature of top flange $\theta_{X-HVB}$	Strength reduction factor $k_{u,\theta,X-HVB}$
20 °C	1.00
100 °C	1.00
200 °C	0.95
300 °C	0.77
400 °C	0.42
500 °C	0.24
600 °C	0.12
>700 °C	0

**Table 7:** Temperature dependent strength reduction factor

The temperature of shear connectors to be considered is the temperature of the upper flange of the beam.

When profiled steel decking is used, the characteristic resistance  $P_{Rk}$  of X-HVB should be further multiplied by the reduction factors which are dependent on decking rib orientation, as presented in Annex C5 of ETA-15/0876.

When designing for a fire situation, the total characteristic shear resistance of X-HVBs is compared to the longitudinal shear force acting on the beam with fire loading.

### 6.2 REHABILITATION

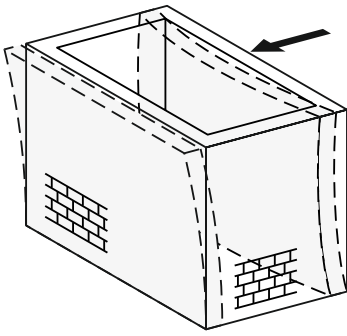
Results of push-out tests carried on in cooperation with the University of Stuttgart indicate similar performance for X-HVBs installed on normal weight concrete and lightweight concrete solid slabs.

According to these results, lightweight concrete can be chosen to utilize all benefits related to a lighter structure (reduced self weight, greater loading capability, better seismic response).

In case of fastening on old steel beams with an ultimate strength of  $F_u \leq 360 \text{ N/mm}^2$  (with a  $F_{u,min} = 300 \text{ N/mm}^2$ ), a conservative reduction factor for design shear resistance  $P_{Rd}$  must be taken into account (please refer to Annex C3 of ETA-15/0876).



**Figure 38:** X-HVB installed with “duck walk” positioning on an old steel beam

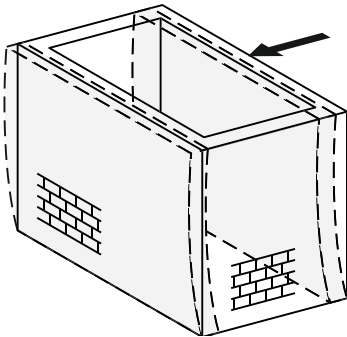


**Figure 39:** Out-of-plane collapse

### 6.3 SEISMIC RESPONSE IN REHABILITATION

A major source of vulnerability of existing buildings (particularly masonry structures with wooden/steel beam slabs) is associated with local collapse mechanisms (out-of-plane response of the bearing walls). By improving connections between the elements, through new composite slabs interconnected with perimeter walls, the seismic behavior of the entire building can be improved.

For proper seismic improvement, it is extremely important to create diaphragms (slabs) capable of transferring the horizontal actions of the earthquake to the shear-resistant walls. Diaphragms help to constrain the out-of-plane deformation of the walls, preventing the collapse, through keeping the box-like configuration; the stiffness of the diaphragms in their plane influences the distribution of the horizontal forces between different sidewalls. To be able to represent an effective constraint, diaphragms have to be able to transmit forces and tensile stresses and must also be properly connected to the walls, as evidenced by Eurocode 8 - Part 3.



**Figure 40:** Out-of-plane collapse prevented, rigid diaphragm

### 6.4 DEFLECTION CONTROL

If the shear connection is only required for deflection control there is no minimum degree of connection. However, maximum allowable connector spacing applies and the steel beam must have sufficient capacity to carry the self-weight and all imposed loads.

For more details, please refer to following technical document(s): ETA-15/0876.

## 7. REFERENCES

### 7.1 LITERATURE

- Kuhlmann, U.; Eggert, F.; Reininger, L. (2015): Push-out Versuche an Hilti X-HVB Schenkeldübeln, Institut für Konstruktion und Entwurf, Universität Stuttgart, 2015-112X. Versuchsbericht.
- Gemander, A. (2015): Durchführung von Querkzugversuchen an Setzbolzenverbindungen, MPA Materialprüfungsanstalt Universität Stuttgart, 29.9.2015
- Beck H., Siemers M., Reuter M. (2011): Powder-actuated fasteners and fastening screws in steel construction, Stahlbau-Kalender. Ernst & Sohn
- Peleska K. (1999): Partial connection of steel and concrete composite beams with HVB shear connectors, Department of Steel Structures, CVUT Praha, Proceedings of 2<sup>nd</sup> European Conference on Steel Structures, Praha, Czech Republic, May 26-29
- Thomas D.A.B., O'Leary D.C. (1998): Composite beams with profiled-steel sheeting and non-welded shear connectors, Steel Construction Today, no. 2, 117 – 121
- Crisinel, M. (1995): Essais "Push-out", HVB 95/125/140 et toles profilees, EPF-Lausanne, ICOM 663-3F, June 1995
- Daniels B.J., Crisinel M., O'Leary D. (1990): Testing of Continuous Span Composite Slabs with Hibond 55 Profiled Sheeting, EPF Lausanne, Publication ICOM 229
- Crisinel M. (1990): Partial-Interaction Analysis of Composite Beams with Profiled Sheeting and Nonwelded Shear Connectors, Journal of Constructional Steel Research 15 (1990) 65 – 98
- Badoux J.C. (1989): The Behaviour and Strength of Steel to Concrete Connection using HVB Shear Connectors (EC4-Design), EPF Lausanne, ICOM 617-4, 6/1989
- Crisinel M., Clenin D. (1985): Neuer Verbunddübel für Konstruktionen mit Stahl/Beton-Verbund, Schweizer Baublatt 77, 9/85
- Tschemmerneegg F. (1985): Zur Bemessung von Schenkeldübeln, eines neuen Dübels für Verbundkonstruktionen im Hochbau, Bauingenieur 60 (1985)

### 7.2 HILTI PUBLICATIONS

The Hilti Direct Fastening Technology Manual (DFTM) is intended as a guide on how to use and choose suitable and correct direct fastening solutions for each specific application. The DFTM provides all the technical data necessary for the correct utilization of Hilti's direct fastening products and describes the main principles and techniques that have an influence on direct fastening.

### 7.3 PROJECT REFERENCES

For project references, contact Hilti Customer Service.

## 8. ANNEXES

**Annex A: Design examples**

**Annex B: Examples of commercial profiled sheeting**

**Annex C: Designation and item numbers**



## ANNEX A: DESIGN EXAMPLES

### 6.1 Substituting welded studs with X-HVB

Section 6.6.3.1 of EN1994-1-1 states that the design resistance of a headed stud, automatically welded to a steel beam, should be the lesser value of:

$$P_{Rd} = \frac{0,8f_u \pi d^2 / 4}{\gamma_V}$$

$$P_{Rd} = \frac{0,29\alpha d^2 \sqrt{f_{ck} E_{cm}}}{\gamma_V}$$

Where:

- $\alpha = 0,2(h_{sc}/d+1)$ , for  $3 \leq h_{sc}/d \leq 4$
- $\alpha = 1$ , for  $h_{sc}/d > 4$
- $\gamma_V$  is the partial safety factor (recommended value = 1.25)
- $d$  is the diameter of the stud shank
- $f_u$  is the specified ultimate tensile strength of the stud material ( $\leq 500 \text{ N/mm}^2$ )
- $h_{sc}$  is the overall nominal height of the stud.

When profiled sheeting is used, the shear resistance of the welded stud is calculated by multiplying the design shear resistance (PRd) by reduction factors that are dependent on profiled sheeting orientation and profiles.

For profiled sheeting with ribs parallel to the supporting beam, the reduction factor  $k_l$  is:

$$k_l = 0,6 \cdot \frac{b_0}{h_p} \cdot \left( \frac{h_{sc}}{h_p} - 1 \right) \leq 1,0$$

For profiled sheeting with ribs transverse to the supporting beam, the reduction factor is governed by **Table 8** (Table 6.2 of EN1994-1-1) and the following expression:

$$k_t = \frac{0,7}{\sqrt{n_r}} \cdot \frac{b_0}{h_p} \cdot \left( \frac{h_{sc}}{h_p} - 1 \right)$$

Where  $n_r$  is the number of studs in one rib, not to exceed two.

Number of studs per rib	Thickness of profiled sheeting	Studs not exceeding 20 mm in diam. and welded through profiled sheeting	Profiled sheeting with holes and studs 19 mm or 22 mm in diameter
$n_r = 1$	$\leq 1 \text{ mm}$	0.85	0.75
	$\geq 1 \text{ mm}$	1.00	0.75
$n_r = 2$	$\leq 1 \text{ mm}$	0.70	0.60
	$\geq 1 \text{ mm}$	0.80	0.60

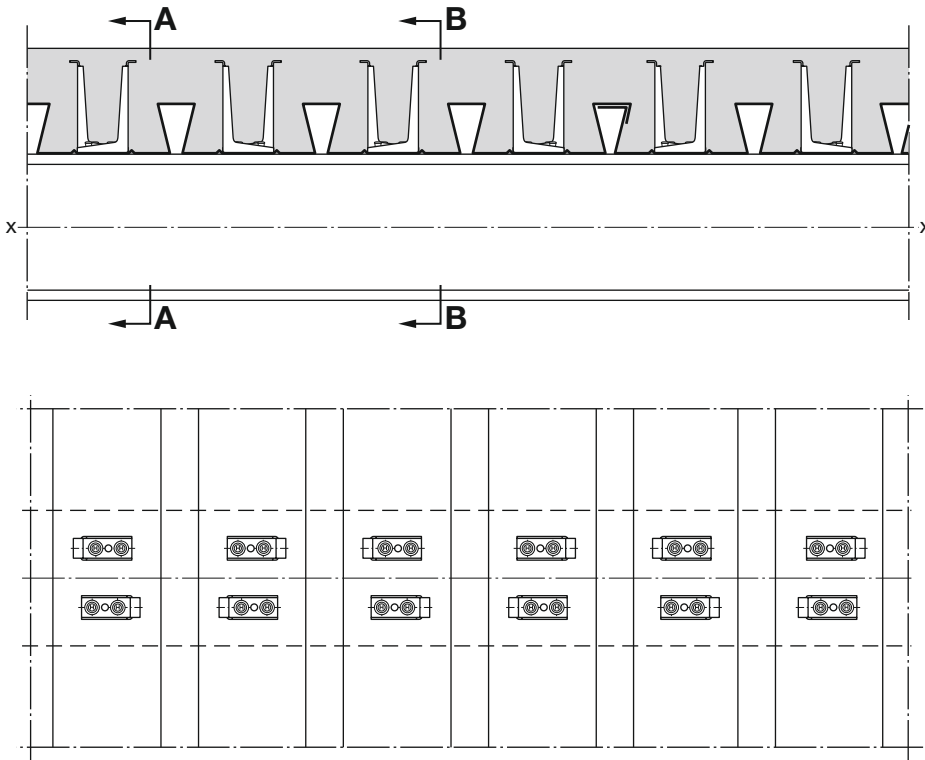
**Table 8:** Upper limits for reduction factors  $k_t$



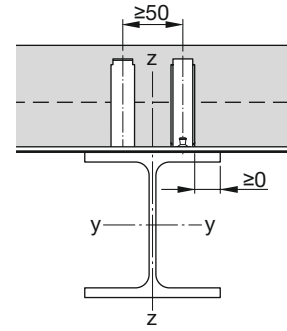
ANNEX B: EXAMPLES OF COMMERCIAL PROFILED SHEETING

**Holorib HR51/150 – Orientation: Longitudinal to direction of beam**

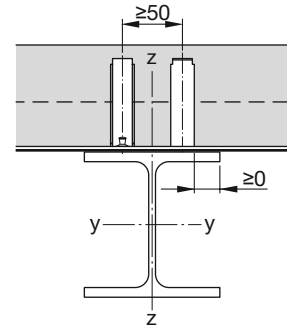
Steel deck supported by beam, 2 X-HVB per rib



**A-A**

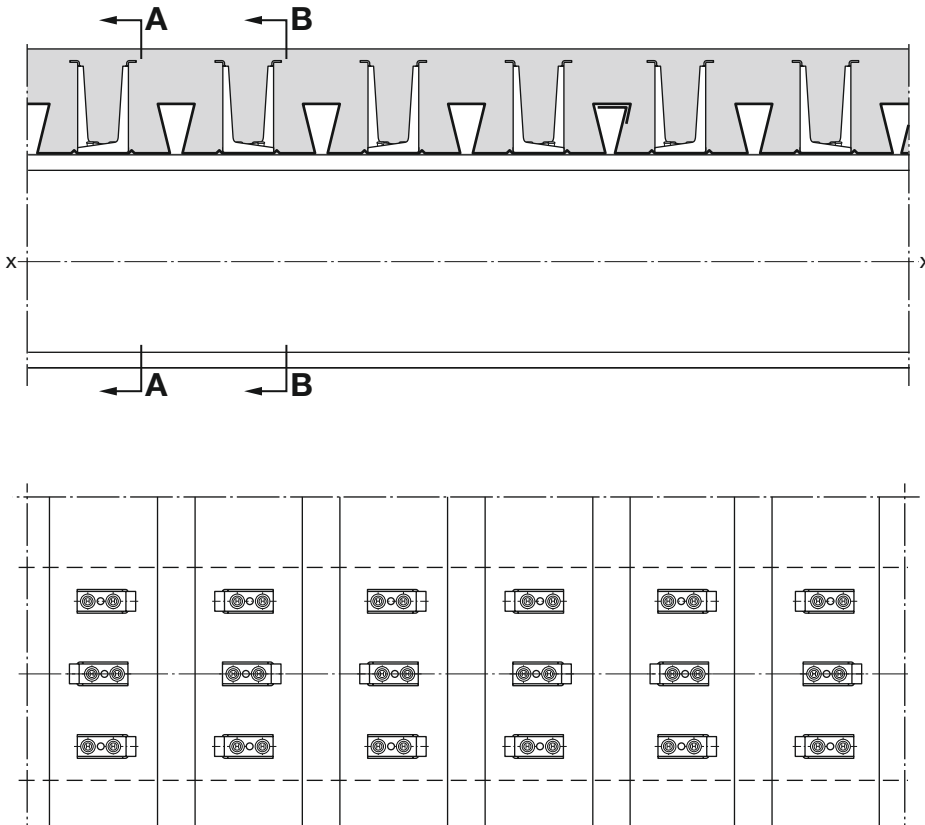


**B-B**

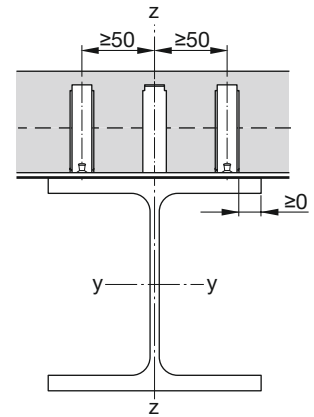


**Holorib HR51/150 – Orientation: Longitudinal to direction of beam**

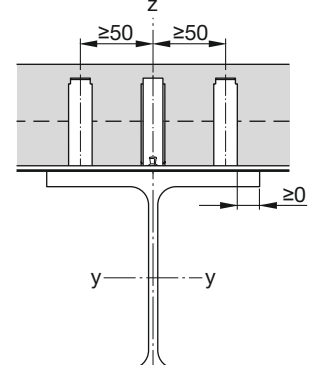
Steel deck supported by beam, 3 X-HVB per rib



**A-A**

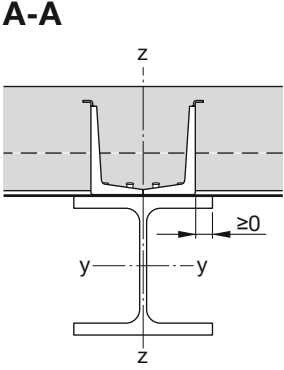
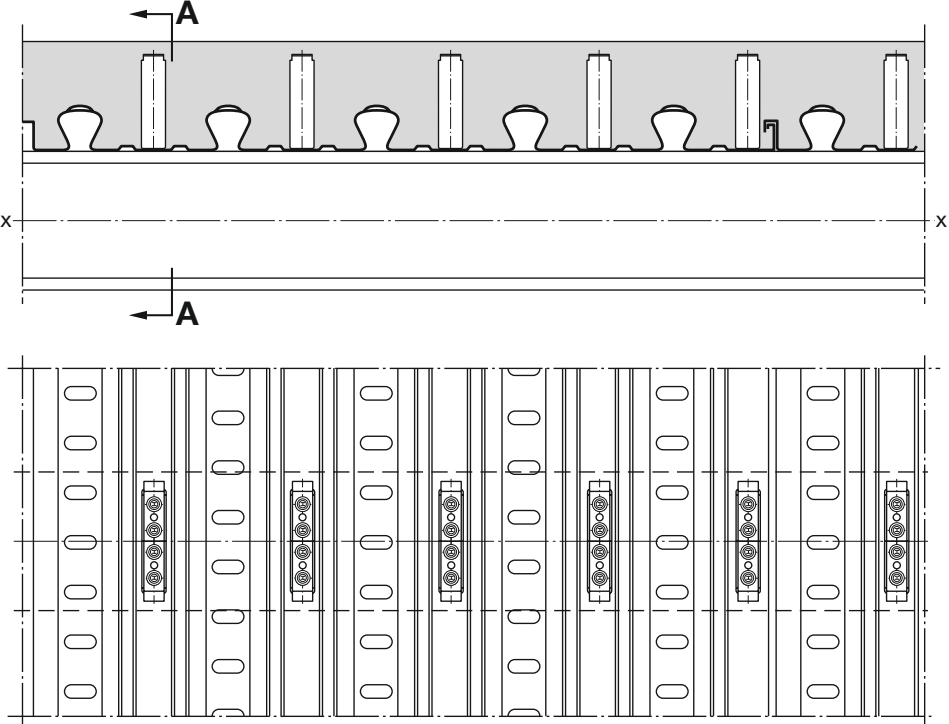


**B-B**



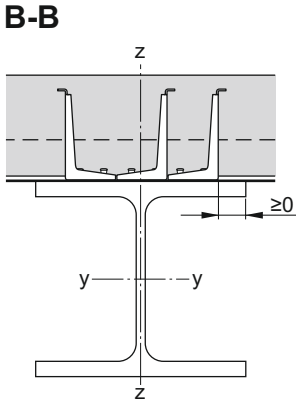
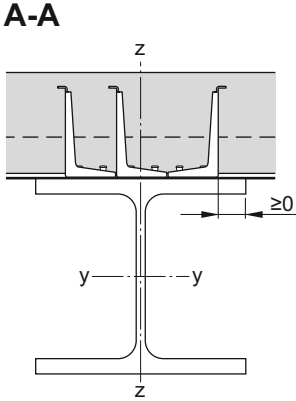
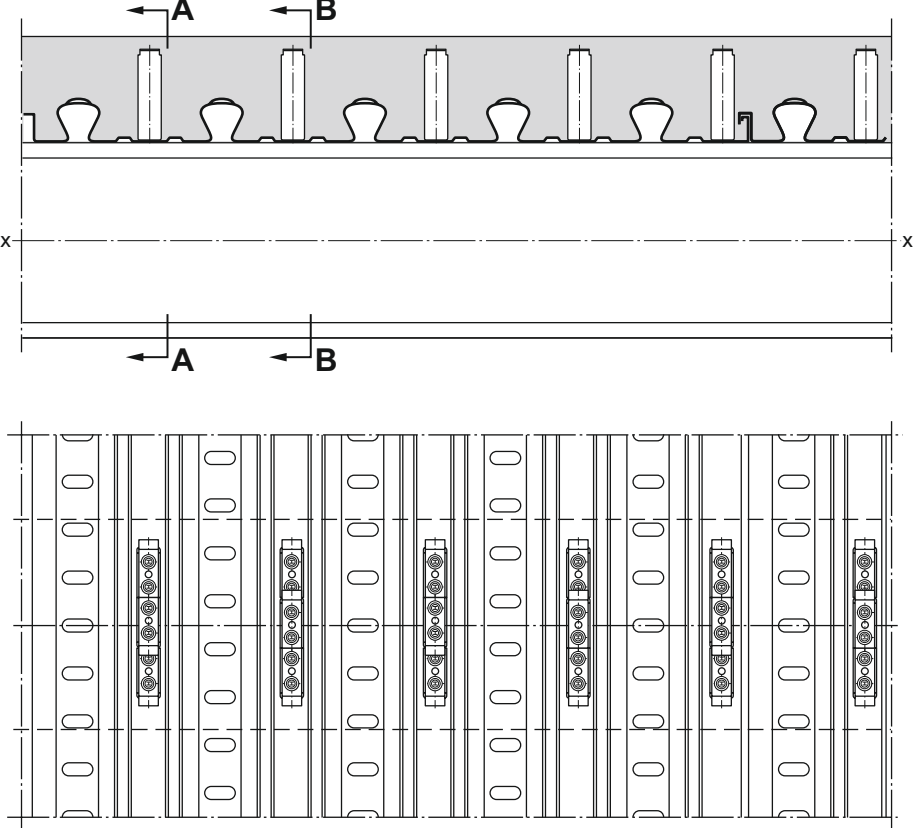
**Cofrastra 40 – Orientation: transverse to direction of beam**

Steel deck supported by beam, 2 X-HVB per rib



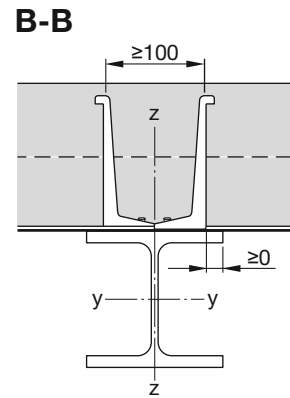
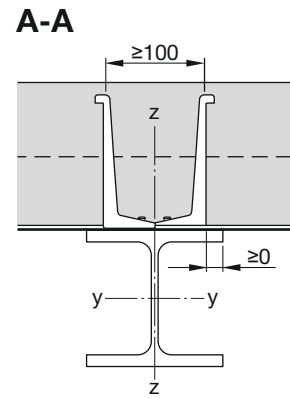
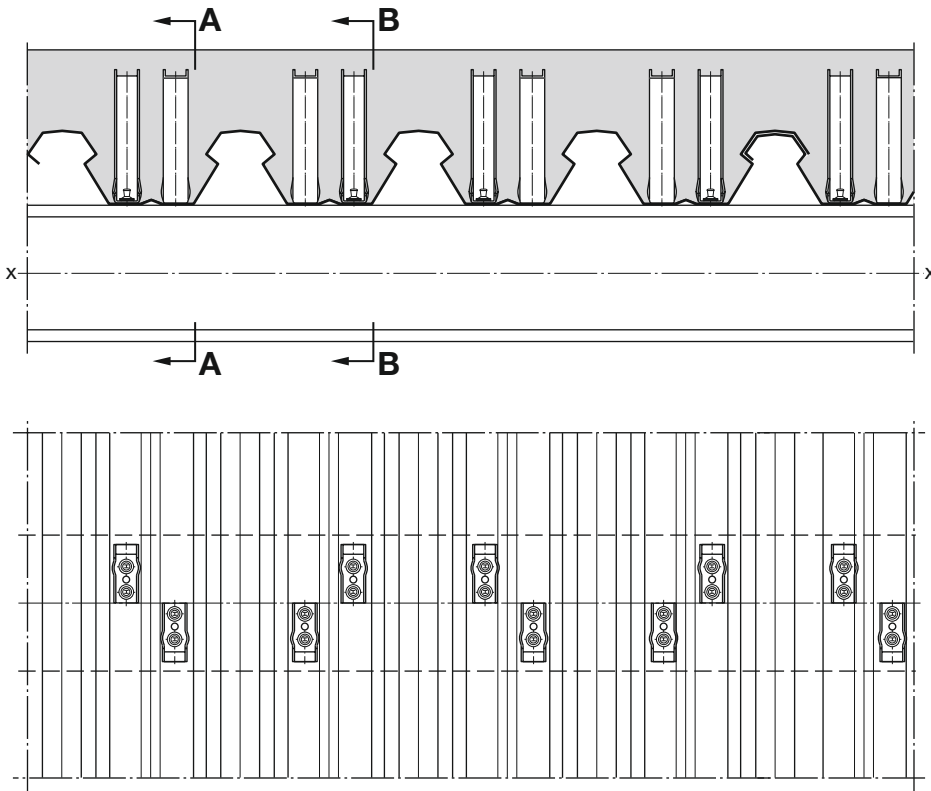
**Cofrastra 40 – Orientation: transverse to direction of beam**

Steel deck supported by beam, 3 X-HVB per rib



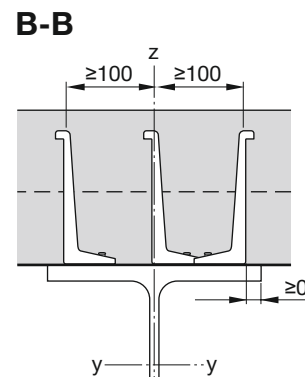
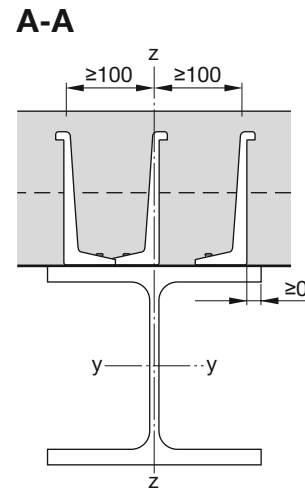
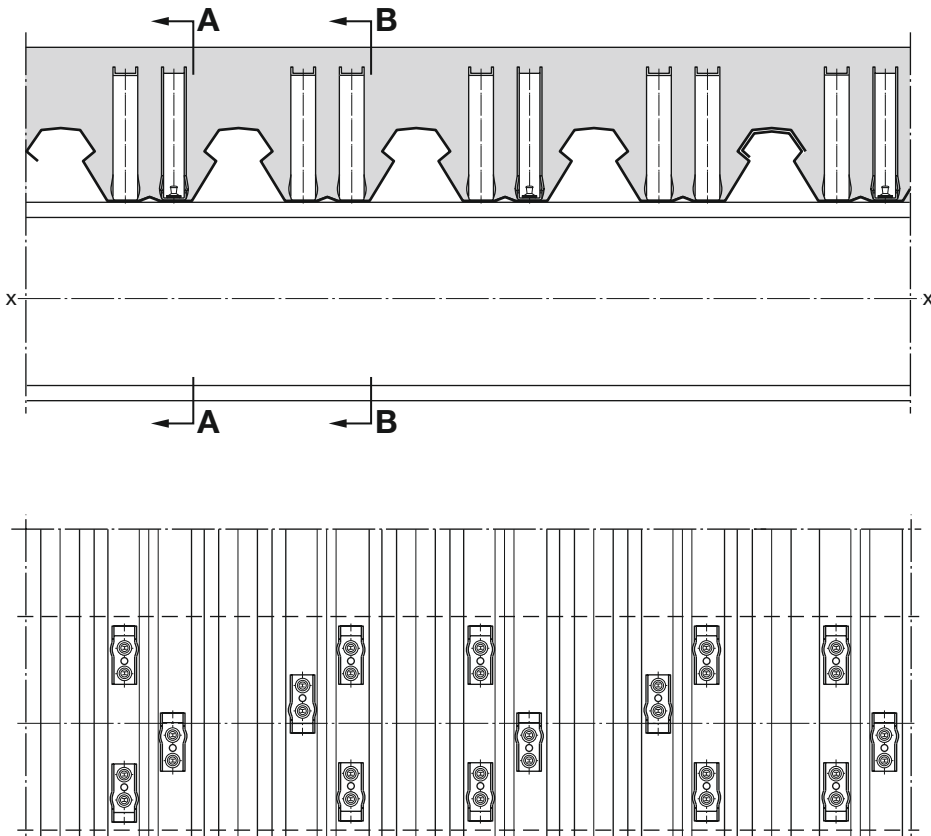
**Cofrastra 70 – Orientation: Transverse to direction of beam**

Steel deck supported by beam, 2 X-HVB per rib



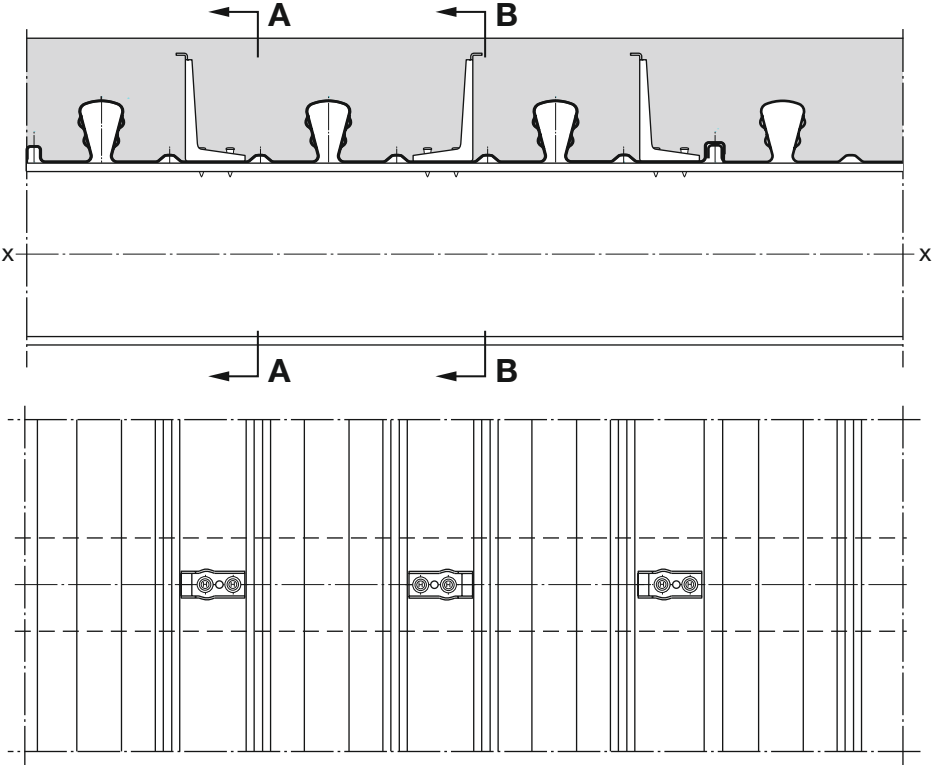
**Cofrastra 70 – Orientation: Transverse to direction of beam**

Steel deck supported by beam, 3 X-HVB per rib

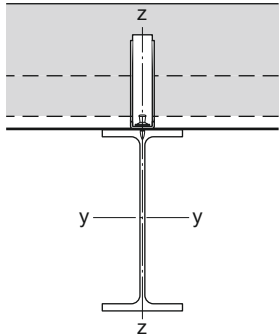


**ComFlor-SR – Orientation: Longitudinal to direction of beam**

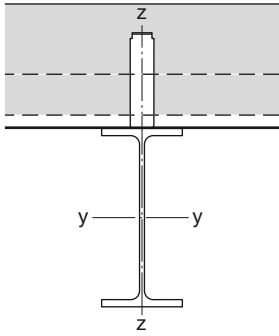
Steel deck supported by beam, 1 X-HVB per rib



**A-A**

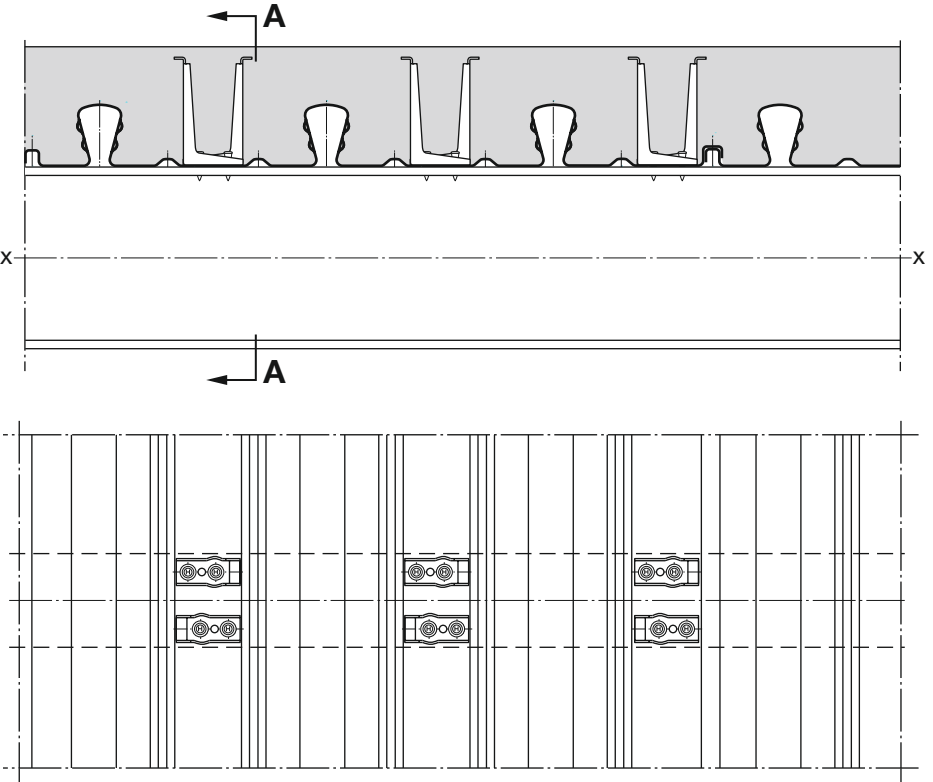


**B-B**

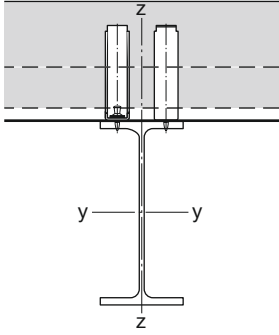


**ComFlor-SR – Orientation: Longitudinal to direction of beam**

Steel deck supported by beam, 2 X-HVB per rib

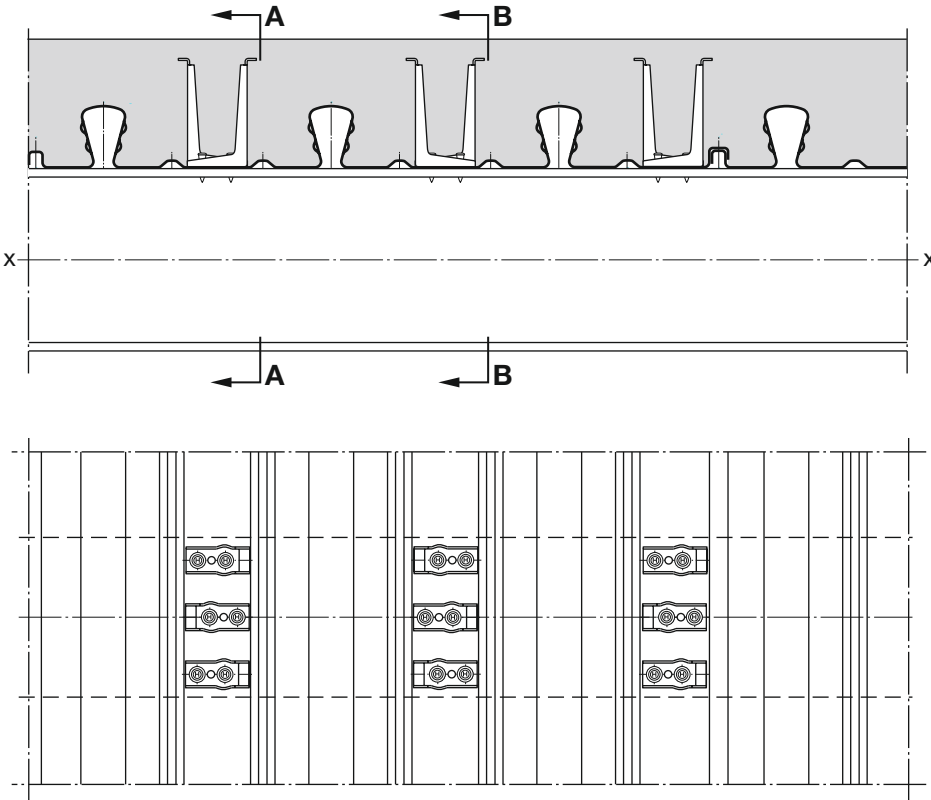


**A-A**

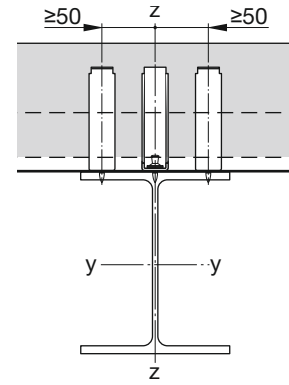


**ComFlor-SR – Orientation: Longitudinal to direction of beam**

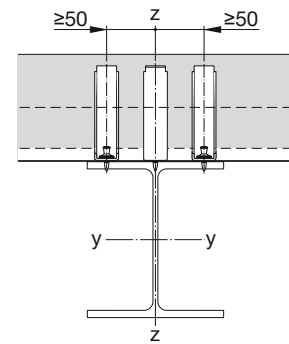
Steel deck supported by beam, 3 X-HVB per rib



**A-A**



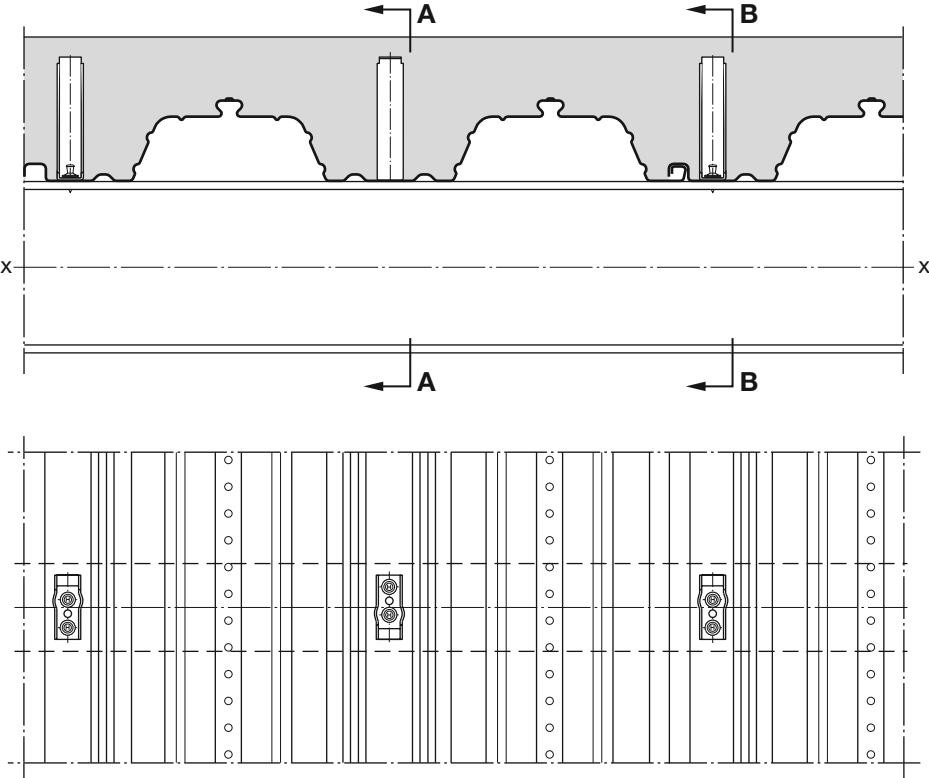
**B-B**



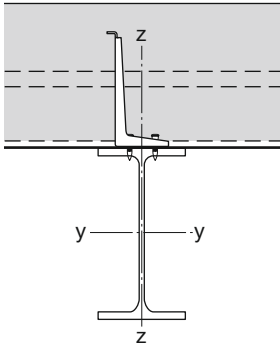


**ComFlor 60-600 – Orientation: Transverse to direction of beam**

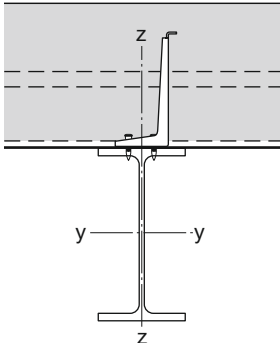
Steel deck supported by beam, 1 X-HVB per rib



**A-A**

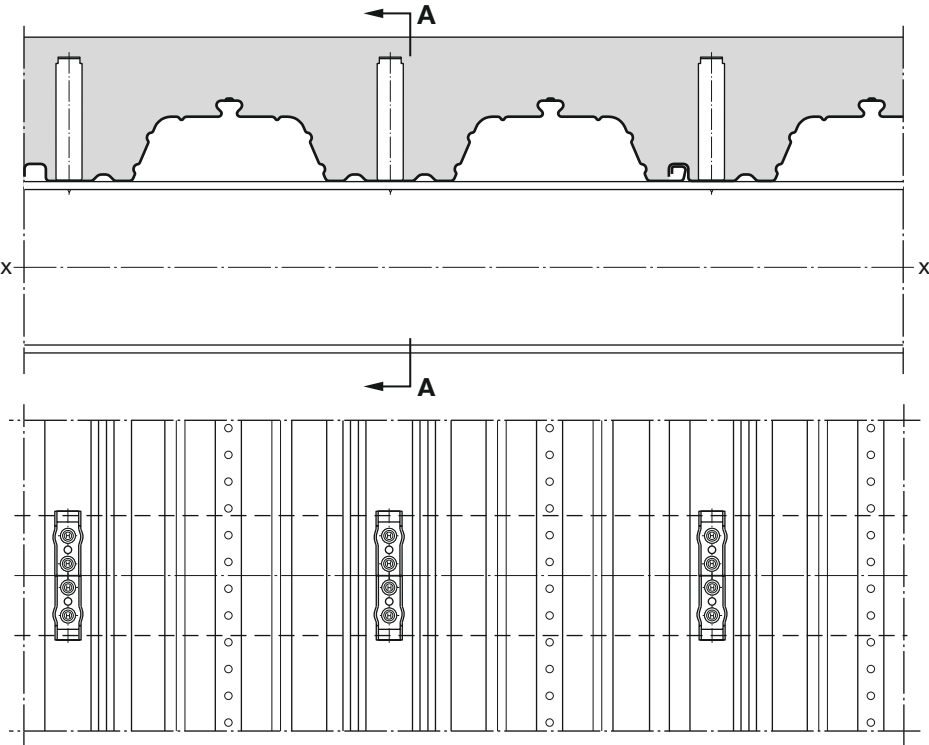


**B-B**

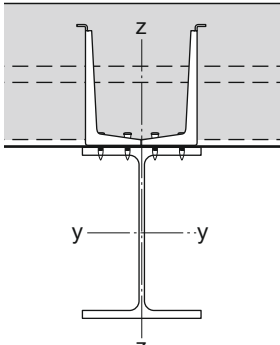


**ComFlor 60-600 – Orientation: Transverse to direction of beam**

Steel deck supported by beam, 2 X-HVB per rib

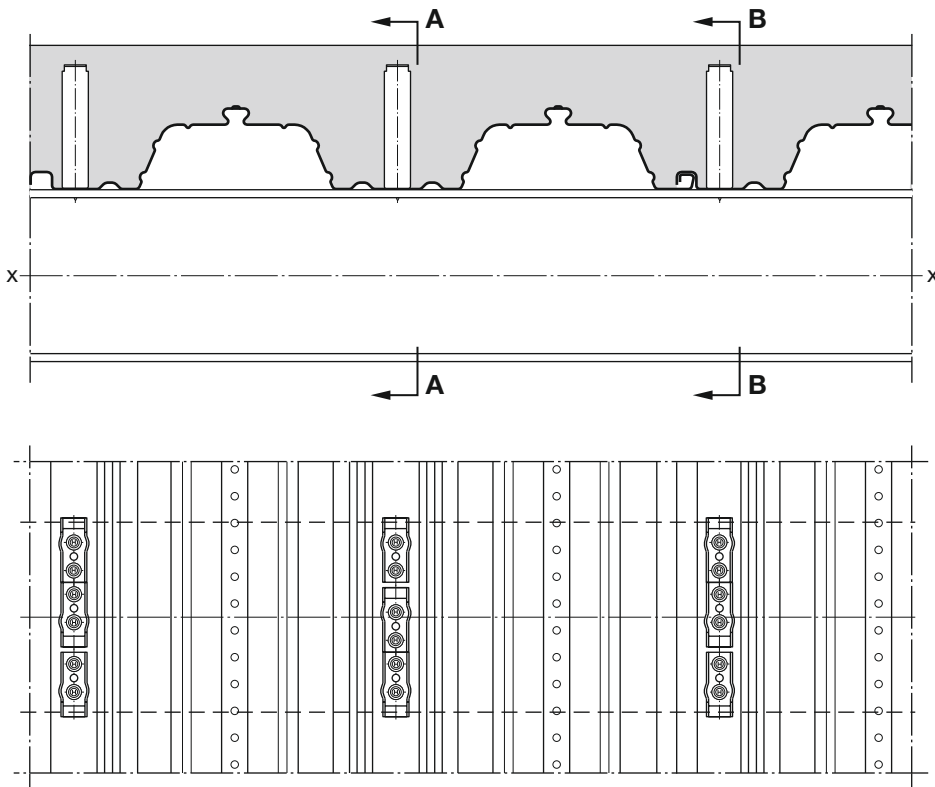


**A-A**

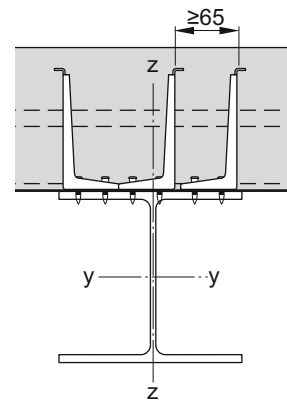


**ComFlor 60-600 – Orientation: Transverse to direction of beam**

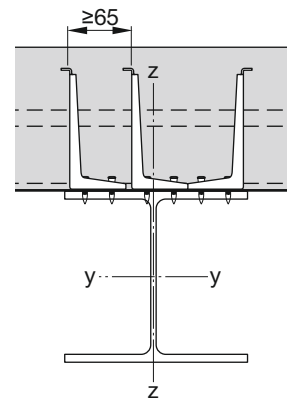
Steel deck supported by beam, 3 X-HVB per rib



**A-A**



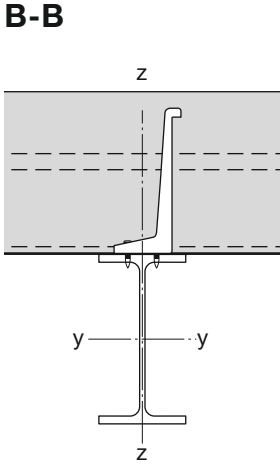
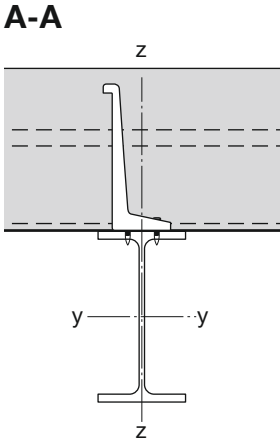
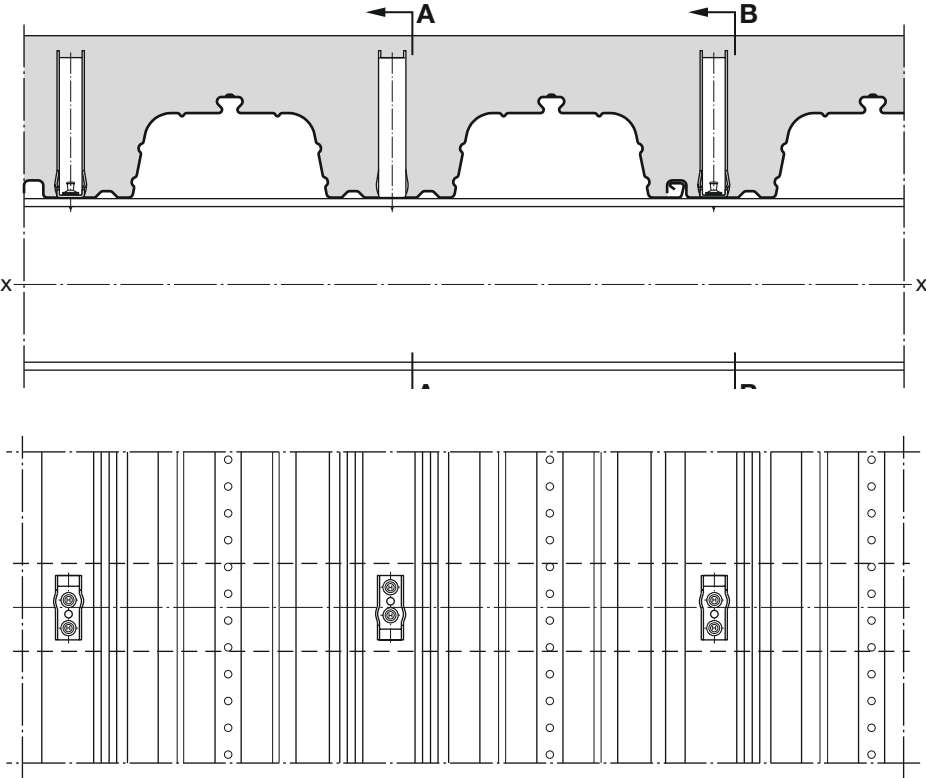
**B-B**



Note: For optimized utilization of available beam width, reduction of the spacing from 65 to 50 mm is possible. However, with respect to tool accessibility, both nails of the left X-HVB of section B..B need to be driven first, before the adjacent X-HVB is fixed.

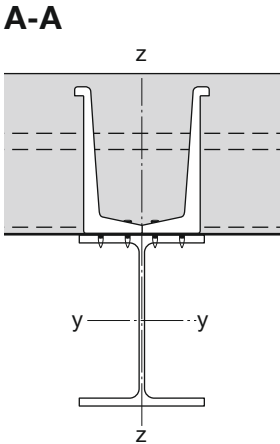
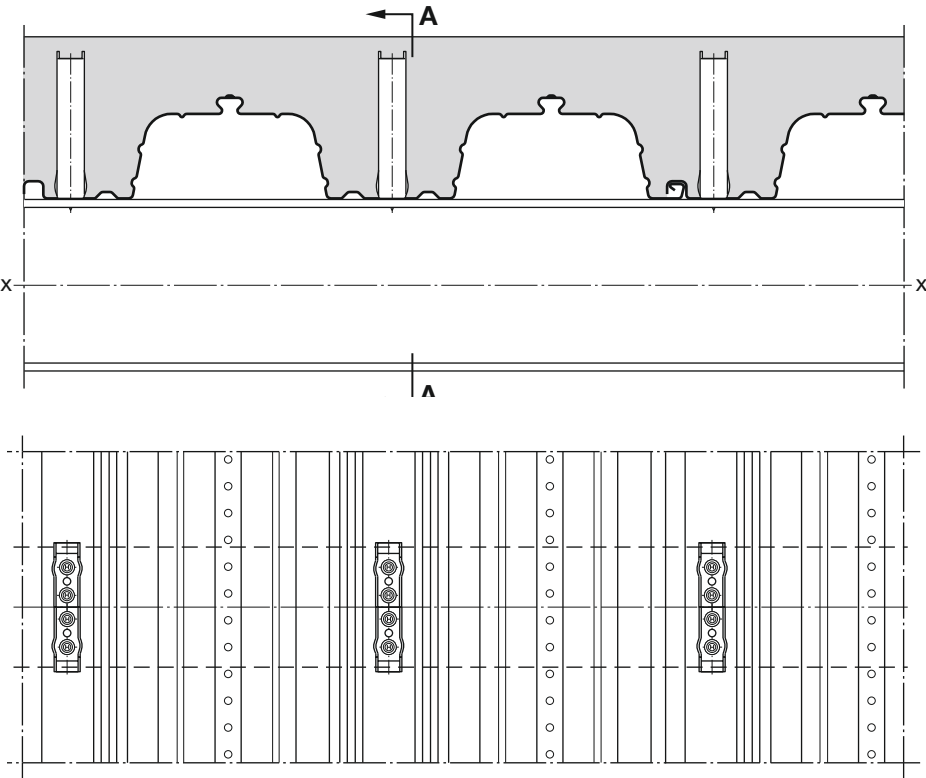
**ComFlor 80-600 – Orientation: Transverse to direction of beam**

Steel deck supported by beam, 1 X-HVB per rib



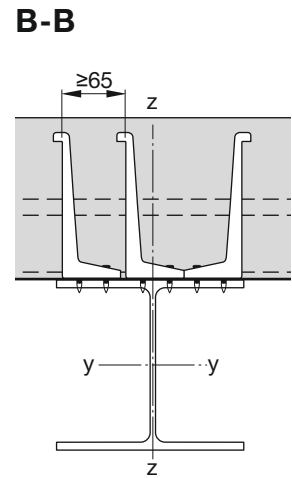
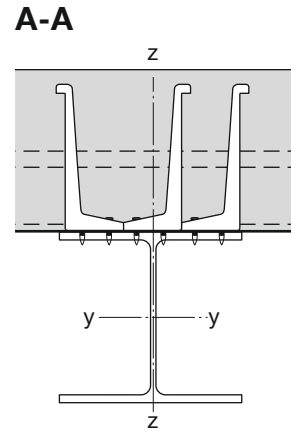
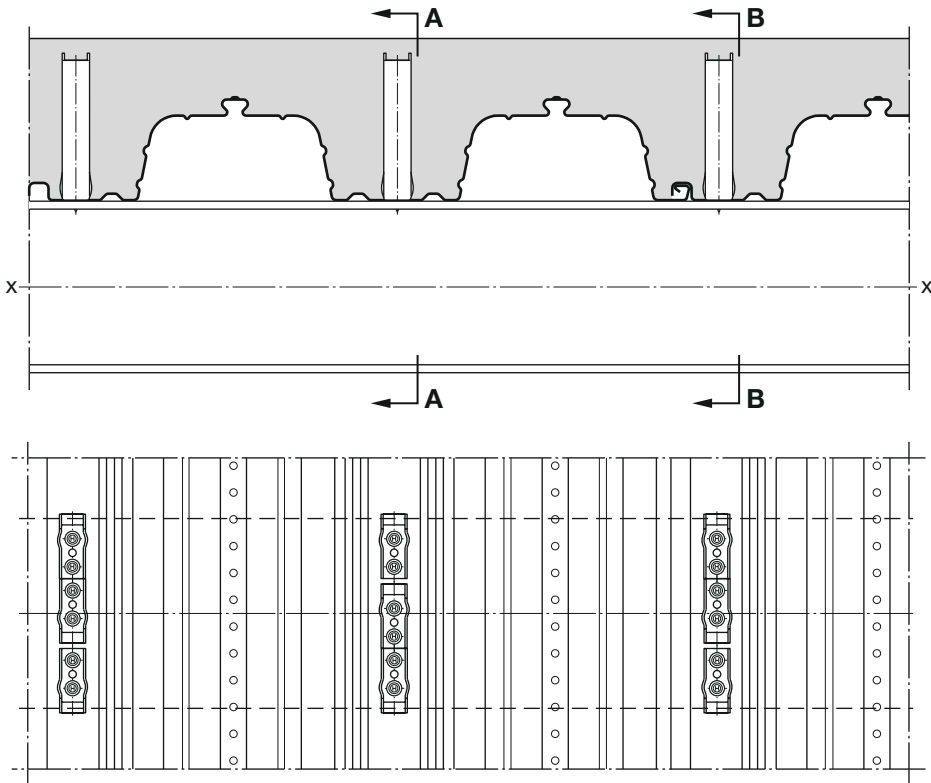
**ComFlor 80-600 – Orientation: Transverse to direction of beam**

Steel deck supported by beam, 2 X-HVB per rib



**ComFlor 80-600 – Orientation: Transverse to direction of beam**

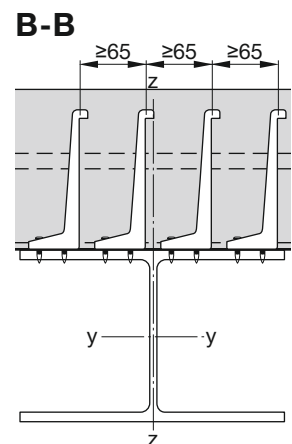
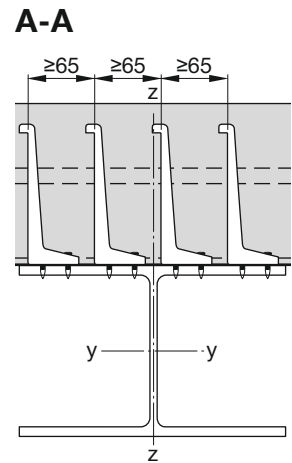
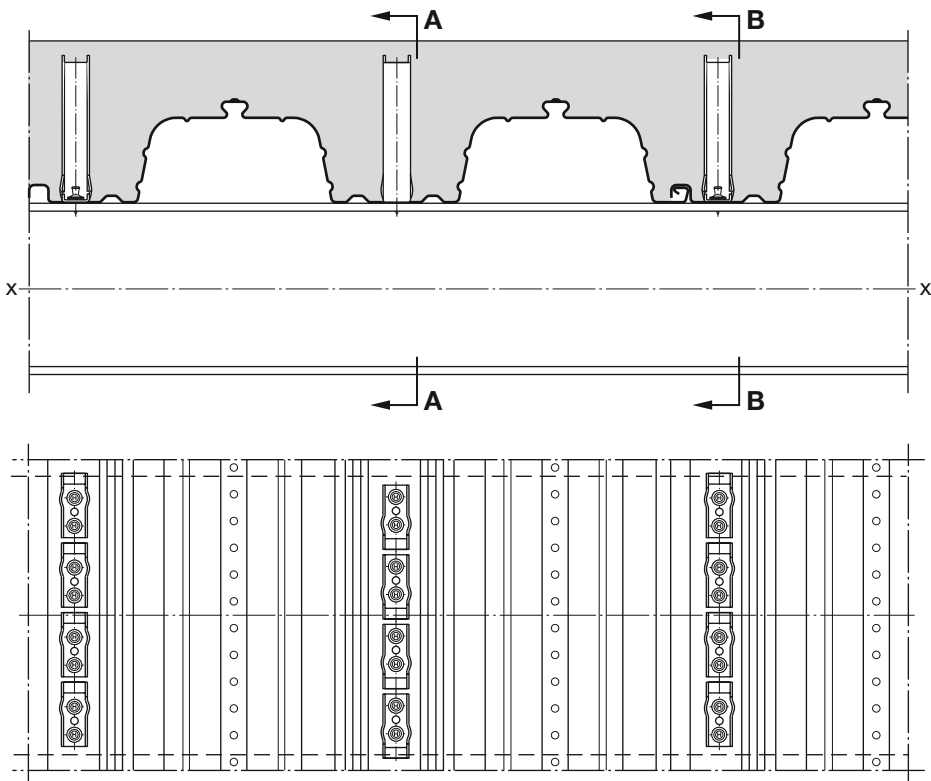
Steel deck supported by beam, 3 X-HVB per rib



Note: For optimized utilization of available beam width, reduction of the spacing from 65 to 50 mm is possible. However, with respect to tool accessibility, both nails of the left X-HVB of section B..B need to be driven first, before the adjacent X-HVB is fixed.F

**ComFlor 80-600 – Orientation: Transverse to direction of beam**

Steel deck supported by beam, 4 X-HVB per rib



## ANNEX C: DESIGNATION AND ITEM NUMBERS

Designation	Category	Item number
X-HVB 40	Shear connector	2112256
X-HVB 50	Shear connector	56467
X-HVB 80	Shear connector	239357, 2336938
X-HVB 95	Shear connector	348179, 2336939
X-HVB 110	Shear connector	348180, 2337010
X-HVB 125	Shear connector	348181, 2322101
X-HVB 140	Shear connector	348321, 2337011
X-ENP 21 HVB	Nail	283512
6.8/18M 10 STD Blue	Cartridge	416485
6.8/18M 10 STD Red	Cartridge	416484
6.8/18M 10 STD Black	Cartridge	416486
DX 76 HVB	Tool	2090391
DX 76 MX	Tool	285789
DX 76 PTR	Tool	384004
X-76-P-HVB	Piston	285493
X-76-P-HVB-PTR	Piston	388847
X-76 PS	Piston stopper	285494
X-76-F-HVB	Fastener guide	285486
X-76-F-HVB-PTR	Fastener guide	388846

Powder adjustment gauges are available in each X-ENP-21 HVB fastener box.







Hilti Aktiengesellschaft  
9494 Schaan, Liechtenstein  
P +423-234 2965

[www.facebook.com/hiltigroup](https://www.facebook.com/hiltigroup)  
[www.hilti.group](http://www.hilti.group)